

NT110

Instruction Manual(EN)



Fourth Edition

This Instruction Manual describes important precautions to prevent any accident and procedures to handle this product.



Read this Instruction Manual carefully to use this product safely.
After reading, keep this in a safe place where users can refer to as needed.



2D-53-0002680C

TAMURA CORPORATION











Safety Precautions

This section describes the "prohibitions" and "precautions" important for you to use NT110 safely. Before use, be sure to read this manual so that you can use the system correctly.

 Warning	<p>This sign gives a message assuming possible human death or severe injury if the system is mishandled ignoring the message given with this sign.</p>
 Caution	<p>This sign gives a message assuming possible human injury or property damage if the system is mishandled ignoring the message given with this sign.</p>

	<p>The Δ symbol shows a message (including a warning) that must be paid attention to. The specific precaution is shown by picture or text near or in the Δ. The message given in the left-hand picture calls attention to "electrical shock."</p>
	<p>⊘ symbol shows a prohibition (prohibited action). The specific precaution is shown by picture or text near or in the ⊘. The message given in the left-hand picture prohibits "disassembly."</p>
	<p>● symbol shows a mandatory message (action that must be taken without exception). The specific precaution is shown by picture or text near or in the ●. The message given in the left-hand picture instructs the user to "remove the power plug from the receptacle."</p>

Warning

 <p>Continuing to use the system with unlikely abnormalities such as smoke and abnormal smell and sound may cause fire and electric shock. After turning off the power of the system's main unit immediately, be sure to remove the power cable plug from the receptacle. After confirming that no more smoke is coming out, contact our sales office for a repair request. Do not attempt to repair the system by yourself, as it is dangerous for the user.</p>	 <p>Fully insert the power cable plug into the power receptacle. Otherwise, it may cause fire or electric shock.</p>
 <p>Should water or foreign materials enter the system, after turning off the power of the system's main unit immediately, remove the power cable plug from the receptacle, and then contact our sales office. Continuing to use the system with foreign materials inside may cause fire or electric shock.</p>	 <p>Do not place heavy objects on the power cable. Also make sure that the power cable is not caught under the system. Otherwise, the cable may be damaged and cause fire or electric shock.</p>
 <p>If cables are damaged such as when the power cable is broken to disconnection and cores are exposed, contact our sales office for a repair. Otherwise, it may cause fire or electric shock.</p>	 <p>Do not place flower vases, cups, containers with water, or small metal items on the system. If water spills or enters the inside, fire or electric shock may be caused</p>
 <p>Do not use the system in a place where liquid may splash on the system's main unit directly. Otherwise, it may cause fire or electric shock.</p>	 <p>Do not damage, process, bend forcefully, twist, pull, or heat the power cable. Otherwise, the cable may be damaged and cause fire or electric shock.</p>
 <p>Use the system only within the voltage range specified in the Instruction Manual. Otherwise, it may cause fire or electric shock.</p>	 <p>Never disassemble, repair, or modify the main unit. Also, never remove the cover. Otherwise, it may cause fire or electric shock.</p>

Caution



When disconnecting the power cable, do not pull the cable. Instead, be sure to hold the power plug to disconnect it. Otherwise, the cable may be damaged and fire or electric shock may be caused.



Before caring for the system, remove the power plug from the receptacle for the sake of safety. Otherwise, it may cause electric shock.



Before moving the system, turn off the power switch, and be sure to remove the power plug from the receptacle, and then remove the connection cords of the external devices. Otherwise, cords may be damaged and fire or electric shock may be caused.



Do not place the power cable near heat generating devices. This may melt the covering of cable and may cause fire or electric shock.



When using the headphones, be careful not to turn the volume too high. Continuously hearing a sound so loud as to irritate your ears for a long time may affect your hearing adversely.



Do not connect/disconnect the power plug with wet hands. Otherwise, it may cause electric shock.



Install NT880 on a flat surface with good ventilation. Otherwise, the internal temperature may rise to cause system malfunctions.



Do not use, expose, or store batteries in high-temperature locations such as direct sunlight or in the car in the hot sun. There is a risk of leakage, overheating, explosion, or fire of the battery. Also, please do not throw in fire or heat.



There is a danger of explosion if you replace the battery by mistake. Please exchange with the same or equivalent type.



Before turning on the power, turn the volume to minimum. Otherwise, you will hear a loud sound suddenly, which may cause impairments such as a hearing loss.



Do not connect/disconnect the power plug with the power switch on. This may cause system malfunctions.



Do not connect/disconnect the module unit and the card unit with the power switch on. This may cause system malfunctions.



Do not put the module unit and the card unit in places where it is susceptible to static electricity (such as on a carpet). This may cause system malfunctions.



If the panel surface becomes dirty, wipe it off using a soft cloth immersed in a small amount of neutral detergent. Never use gasoline, alcohol, cleanser, or freon.



The module unit and the card unit were adjusted when installed. Please know that if changes are made by the customer after delivery such as replacing parts or adjusting the internal trimmer, maintaining of the performance afterward cannot be guaranteed.



Do not use in places where corrosive gas is generated. There is a possible cause of the malfunction or failure.



For protection from electric shock, please plug the power cable plug into an outlet with a protective earth terminal correctly connected to earth. Using it without connecting a protective earth may cause electric shock.



Place it in a location that is easily accessible to the power plug. If you feel abnormal, immediately turn off the power and unplug the power plug from the outlet. Also, even when the power is turned off, a small current flows. Always unplug the power plug from the outlet when not using this product for a long time. When installing this equipment in system, please construct a system that can be shut off with a breaker or the like.

Disposing of this Equipment

When disposing this equipment, contact an authorized industrial waste disposal operator to handle the disposal since this equipment needs to be disposed as an industrial waste.

Since the consumable parts including faders, fans, and operating knobs tend to lose their effectiveness with frequency and time of use, replacement is needed according to consumption. We recommend carrying out a periodical maintenance. For repair or maintenance, consult with our sales representatives or service department shown on the end of this manual. TAMURA owes no responsibility or liability for any failure due to improper use or alteration.

Since any dust, water, or oil inside a fader will cause noise or level fluctuation, take measures like storing it in a special case or covering it while not in use.

Copyright

Copyright © 2017 TAMURA Corporation. All Rights Reserved. Do not duplicate or replicate without permission.

About the latest version of instruction manual

Specifications and appearance etc. described in this manual are subject to change without notice for improvement.

Please download the latest version instruction manual from the website of TAMURA Corporation.

About the latest firmware

The latest firmware of this device is published on the website of TAMURA Corporation.

Please download the latest firmware and installation instructions from the website of TAMURA Corporation.

TAMURA Corporation website

<http://www.tamura-ss.co.jp>

Precautions on Installation of NT110

Install NT110 with special care to ventilation according to the following precautions:

- 1) Do not block ventilation holes and fans on the back and bottom.
- 2) When you embed NT110 in a table or desk, use a structure in consideration of air flow.
- 3) When you stack NT110 mounted on a rack, prevent thermal influence from equipment installed below it.

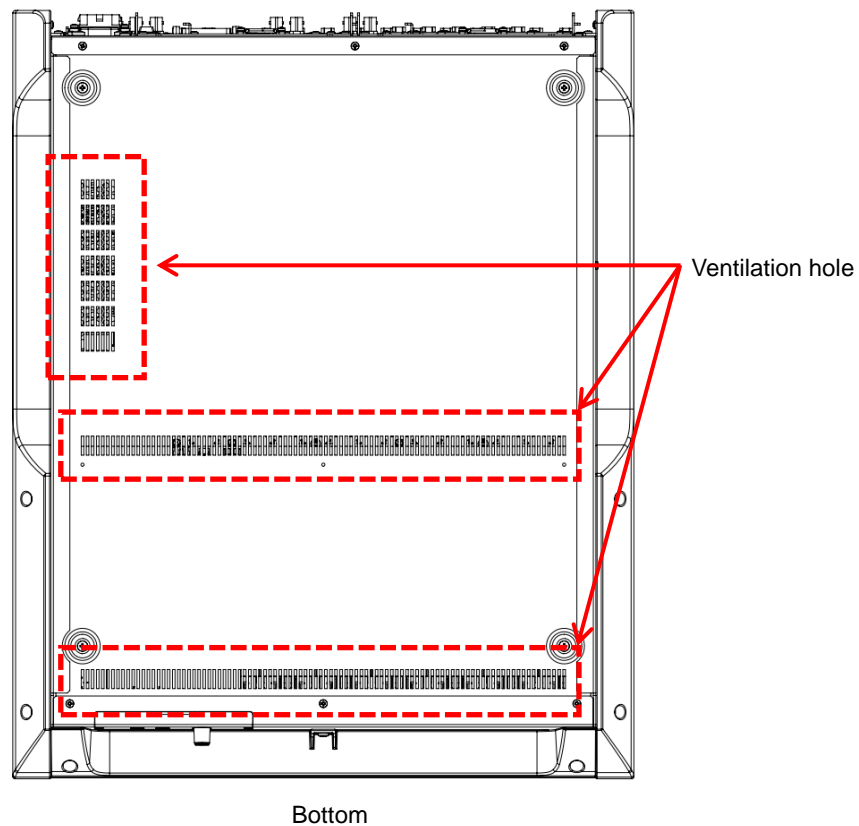
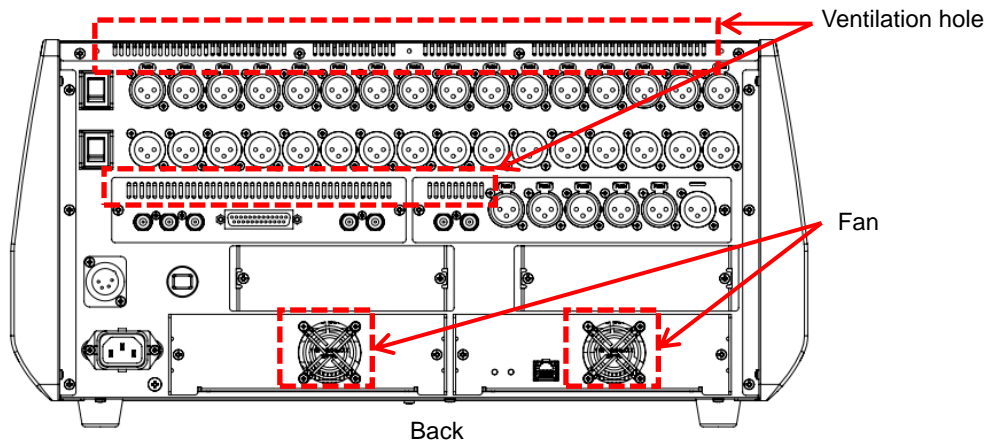

Table of Contents

1. Overview	1
2. Features	1
3. External View	2
3-1 Rear Panel	2
3-2 Front Panel	3
4. Audio Block Diagram	4
5. Configuration	5
6. Rating and Performance	6
6-1 General Rating	6
6-2 Input/Output Rating	6
6-3 Reference Level	7
6-4 Bus and Monitor	7
6-5 Audio Performance	8
6-6 Audio Control Parameters	9
7. Exterior Features	10
7-1 Rear Panel	10
7-1-1 AC INPUT	10
7-1-2 DC INPUT/NFB	11
7-1-3 POWER SW	11
7-1-4 MIC/LINE INPUT	12
7-1-5 LINE OUT	12
7-1-6 TB/COMM/SUM/AES3	13
7-1-7 AES3/METER/SYNC	13
7-1-8 IO CARD SLOT	14
7-1-9 DSP CARD SLOT	14
7-1-10 Connection of DSP CARDS with NT Mix	15
7-2 Front Panel	16
7-2-1 Touch Panel	17
7-2-2 Preset Program	17
7-2-3 DSP/On Air	17
7-2-4 Bus Master	18

7-2-5	OSC.....	18
7-2-6	Monitor.....	18
7-2-7	Talk Back.....	20
7-2-8	Mixer Control.....	21
7-2-9	Bank/Layer.....	21
7-2-10	Select Encoder.....	22
7-2-11	Fader.....	22
7-3	Headphone Panel.....	23
8.	Connector Pin List.....	24
9.	Outline Drawing.....	26
10.	Appendix.....	27
10-1	Adding DSP CARD.....	27
10-1-1	Precautions.....	27
10-1-2	Additional Procedure.....	27
10-1-3	Operation Check after Adding.....	27
10-2	Replacing DSP CARD.....	28
10-2-1	Precautions.....	28
10-2-2	One DSP CARD Configuration.....	28
10-2-3	Two DSP CARD Configuration (Replacing Primary DSP CARD).....	29
10-2-4	Two DSP CARD Configuration (Replacing Secondary DSP CARD).....	29
10-2-5	Operation Check after Replacement.....	29
10-3	DSP CARD Installation Method.....	30
10-3-1	Remove DSP CARD (FAN CARD).....	30
10-3-2	Install DSP CARD.....	31
10-4	IO CARD Installation Method.....	32
10-4-1	Removing Blank Panel.....	32
10-4-2	Install IO CARD.....	32
10-5	Removing Exterior Equipment (Side Panels and Pad).....	33
10-5-1	Removing Side Panels.....	33
10-5-2	Removing Pad.....	34
10-6	About Fixing Screw Holes.....	35
10-6-1	Four Fixing Screw Holes at A.....	35
10-6-2	Five Fixing Screw Holes at B.....	35
10-7	How to Install Accessory Sunshade.....	36
10-8	Initializing Internal Data.....	37
10-9	Backing Up and Uploading NT110 Data.....	38
10-9-1	Transferring Backup Data from NT110 to PC File (Backup).....	38
10-9-2	Transferring Backup Data from PC File to NT110 (Upload).....	39
10-10	Factory Default Password.....	40

1. Overview

NT110 is an all-in-one, compact digital mixer of the NT series, which inherits the functions and reliability of our flagship model NT880.

Despite its compact size, NT110 realizes redundancy (optional) of power input and an audio signal processing part and is suitable for applications that require high reliability, such as OB vans, live broadcasting, production, and television and radio studios.

2. Features

◆ Light and Compact Design

- (1) This light and compact product can be installed in OB vans, where space is limited, or can be used for portable applications.
- (2) EIAJ 19-inch rack mount size (with exterior removed)
- (3) Multi-channel simultaneous operation with physical 16 ch Faders and 2 Layers x 3 Banks configuration
- (4) An all-in-one model with built-in analog and digital input/output

◆ Original Technologies

- (1) Built-in audio signal processing with a high dynamic range based on 32-bit floating point operations. Mixing can be performed without being conscious of the internal level diagram.
- (2) Redundant configuration of audio signal processing and controllers are available for the first time in the compact class.

◆ Operational Safety

- (1) Power supply in a redundant configuration, allowing for AC and DC input
- (2) Applications that require high reliability are supported with a redundant configuration of audio signal processing and controller-mounted DSP CARDS (optional).
- (3) Microphone input achieves 36 dB of head room. Sudden excessive input can be resisted.
- (4) The system uses no advanced OS but is composed based on firmware, realizing high stability and quick startup.

◆ Usability

- (1) Installation of 16 ch physical faders allows for simultaneous multi-channel operation despite its compact size.
- (2) The large touch panel displays many input/output meters for monitoring to allow for viewing of the entire mixer.
- (3) The large touch panel offers intuitive operability.
- (4) The inherited operability of the NT series facilitates learning of the mixing operation.

◆ Efficient and Flexible System

- (1) Cascade connection (optional) enables addition of input channels that can be simultaneously used.
- (2) Two card slots are provided. According to the system, necessary audio input/output channels or GPIO control units can be added.

3. External View

3-1 Rear Panel

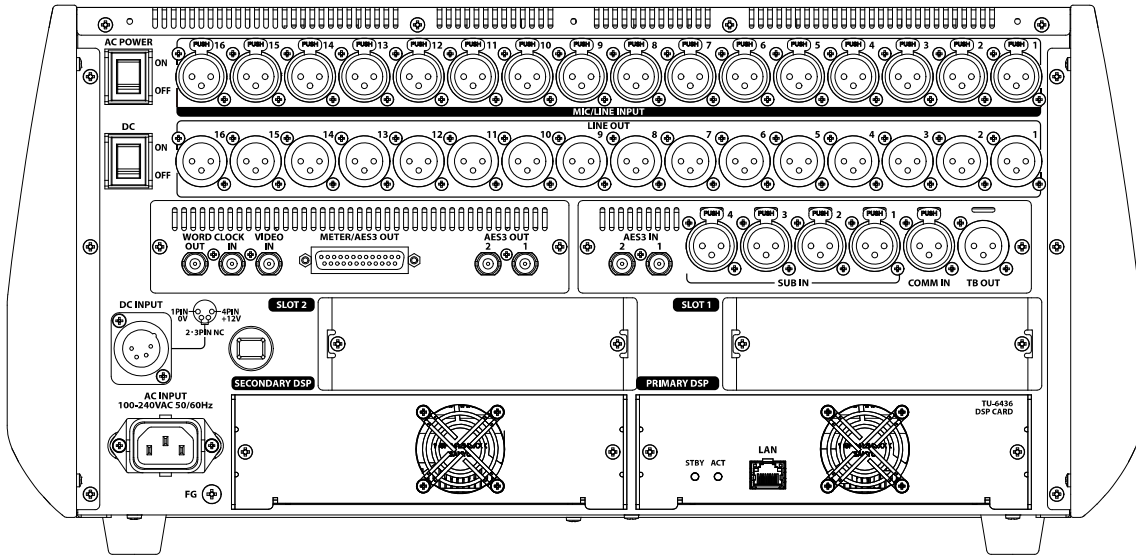

3-2 Front Panel

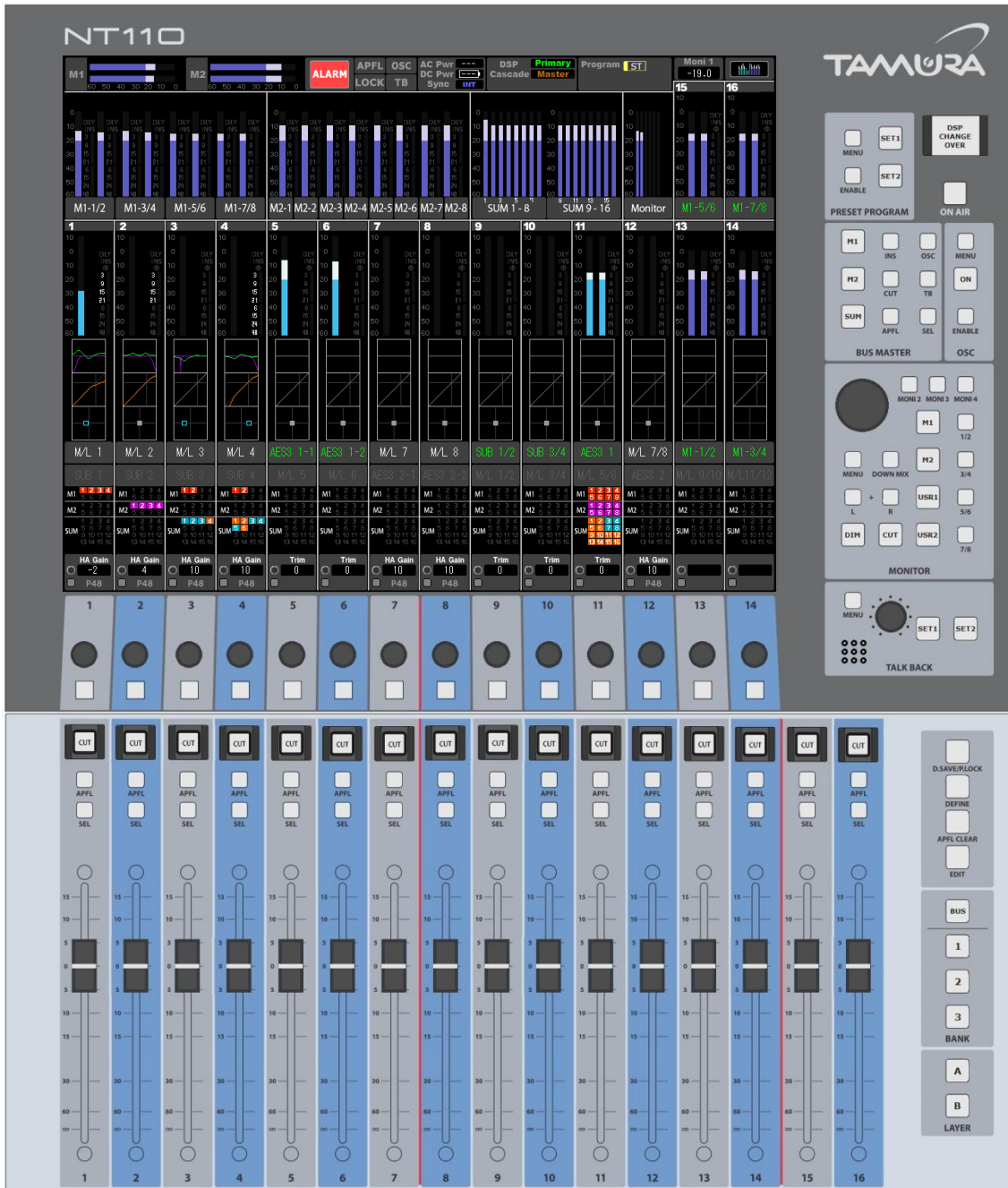

4. Audio Block Diagram

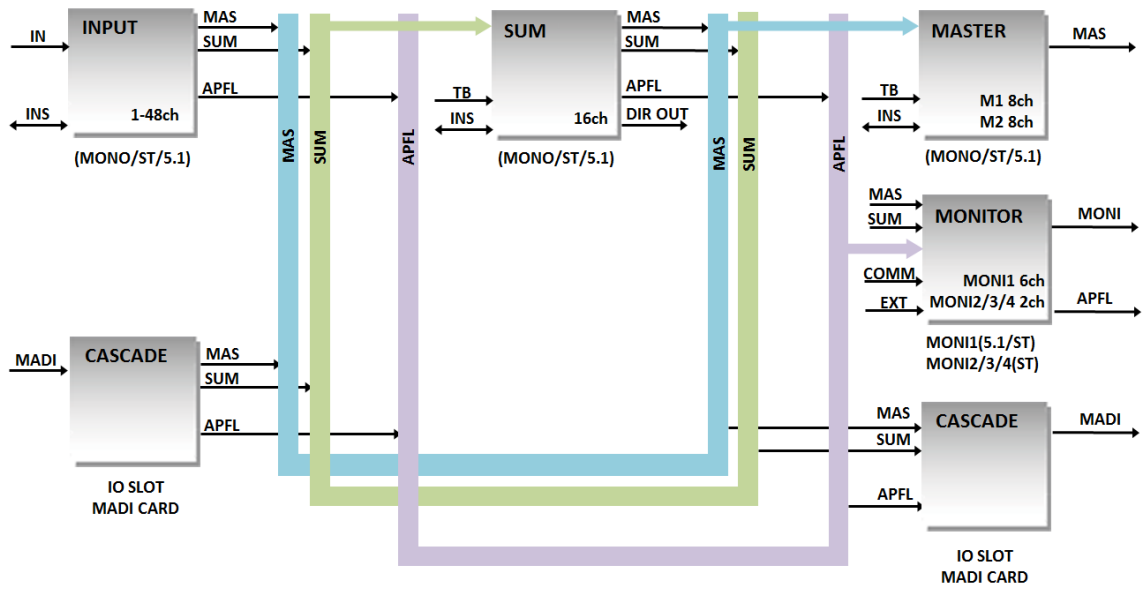

5. Configuration

Product code	Model	Name	Quantity	Remarks
M-21200550-00	NT110	DIGITAL AUDIO MIXER	1	NT110 main unit
M-21300269-00	TU-6436	DSP CARD	1	One pre-installed on the main unit
		AC CORD 2m (JP)	1	Accessories
		Sun-Shade	1	Accessories
		Instruction Manual(JP)	1	Accessories

- * The table above shows the products that come standard with the main unit and does not include any options.
- * Since the attached AC CORD is exclusively for Japan, it can not be used outside of Japan.
If you plan to use this machine outside of Japan, prepare AC CORD of your country separately.

6. Rating and Performance

6-1 General Rating

Supply voltage (AC).....	100 to 240 V	50/60 Hz
Supply voltage (DC).....	12 /14.8 V	
Power Consumption	125 W	
External dimensions (with side panels and pads) excluding protrusions.....	490(W)×221.5(H)×606(D) mm	
External dimensions (without side panels and pads) excluding protrusions.....	430(W)×220.5(H)×550(D) mm	
Weight (with side panels and pads, without options)	16.5 kg	
Operating temperature range	-10°C	to +40°C
Operating humidity range	20%	to 80%
Operating condition.....	Continuous	

6-2 Input/Output Rating

Transmission frequency range (Fs=48 kHz)	20 to 20,000 Hz
Transmission frequency range (Fs=96 kHz)	20 to 40,000 Hz
Sampling frequency	48/96 kHz
Number of signals processed (Fs=48/96 kHz)	80/40 ch
Cascade connection mode (Fs=48/96 kHz)	160/80 ch
Synchronization signal input	
VIDEO INPUT	VIDEO (NTSC/PAL)
WORD CLOCK INPUT.....	WORD (TTL/1 Vpp)
AES3id INPUT	AES3id
Synchronization signal output	
WORD CLOCK OUTPUT.....	WORD (TTL)
Audio input	
MIC/LINE INPUT	Monaural 16 (XLR)
-64 dBu to +10 dBu/4 kΩ or more	
SUB INPUT	Monaural 4 (XLR)
-20 dBu/0 dBu/+4 dBu/10 kΩ or more	
AES3id INPUT	Stereo 2 (BNC)
AES-3id (AES/EBU format)/75Ω unbalanced	
Sample Rate Converter (SRC) On: 30 to 100 kHz	
COMM INPUT	Monaural 1 (XLR)
-15 dBu/10 kΩ or more	
Audio output	
LINE OUTPUT	Monaural 16 (XLR)
0 dBu/+4 dBu / 55 Ω or less	
AES3id OUTPUT	Stereo 2 (BNC)
AES-3id (AES/EBU format)/75Ω unbalanced	
Output signal level 1Vp-p/Output sampling frequency 48/96 kHz	
Number of output bits 24 bits	
TB OUTPUT.....	Monaural 1 (XLR)
HEADPHONE OUTPUT	Stereo 1 (Standard jack x 2)
Output power 100mW / 35 Ω	
Meter/AES3 output	

AES3 OUTPUT	Stereo 4 (Dsub)
AES-3 (AES/EBU format)/110 Ω balanced	
Output signal level 2 Vp-p at minimum/Output sampling frequency 48/96 kHz	
Number of output bits 24 bits	
IO CARD SLOT	2SLOT
DSP CARD SLOT (Primary SLOT equipped as standard).....	2SLOT
Control input/output	
LAN PORT (DSP CARD)	1 port (LAN)

6-3 Reference Level

Audio reference input level	
Analog (MIC/LINE INPUT)	-64 dBu to +10 dBu
Analog LINE (SUB INPUT)	-20dBu/0dBu/+4 dBu
Audio reference output level	
Analog LINE (LINE OUTPUT)	0dBu/+4 dBu
Audio reference input/output level	
Digital	-18 dBFS/-20 dBFS
HA head room.....	20 to 36 dB

6-4 Bus and Monitor

DSP Channel (total 80ch@FS48kHz)

Input.....	48 ch (Mono/Stereo/5.1 Surround)
M1.....	8 ch (Mono/Stereo/5.1Surround+Stereo/5.1Surround+Downmix)
M2.....	8 ch (Mono/Stereo/5.1Surround+Stereo/5.1Surround+Downmix)
SUM.....	16 ch (Mono/Stereo/5.1 Surround)

Mix Bus

M1.....	8 ch (Mono/Stereo/5.1 Surround)
M2.....	8 ch (Mono/Stereo/5.1 Surround)
SUM.....	16 ch (Mono/Stereo/5.1 Surround)
APFL.....	6 ch (Stereo/5.1 Surround)
BT	1 ch (Mono)

Monitor

MONI1	6 ch (Stereo/5.1 Surround)
MONI2	2 ch (Stereo)
MONI3	2 ch (Stereo)
MONI4	2 ch (Stereo)
HEADPHONE	2 ch (Stereo)

* A number of channels is converted to a number of monaural channels.
 * For FS 96 kHz, the total number of DSP Channels and Mix Buses is one half of the above number of channels.

6-5 Audio Performance

* Performance assumes normal service condition unless otherwise specified

<Normal service condition>

The normal service condition means that the specified power supply is used, where each component is correctly connected as per the system diagram, and then adjusted according to the specified level diagram. However, filters and equalizers are off.

Amplification allowance

(For the rated value at 1 kHz)

Analog input/output (Microphone-system)..... Within ± 2.0 dB

Analog input/output (Line-system)..... Within ± 1.0 dB

Digital input/output Within ± 0.3 dB

Amplification frequency characteristic

(Assumes 1 kHz as the reference at $F_s=48$ kHz and within transmission frequency range.)

Analog input/output (+4dBu IN)

FS 48 kHz Within ± 0.6 dB (20 to 20 kHz)

FS 96 kHz Within ± 0.6 dB (20 to 40 kHz)

Digital input/output

FS 48 kHz Within ± 0.1 dB (20 to 20 kHz)

FS 96 kHz Within ± 0.1 dB (20 to 40 kHz)

THD+N

(using 22 Hz HPF and 22 kHz LPF/ $F_s = 48$ kHz, 40 kHz LPF/ $F_s = 96$ kHz within transmission frequency range.)

Reference level input

Analog input/output (Microphone-system)..... Within 0.2%

Analog input/output (Line-system)..... Within 0.03%

Digital input/output Within 0.03%

When inputting a level equivalent to reference input level + head room -1 dB

Analog input/output (Microphone-system)..... Within 0.4%

Analog input/output (Line-system)..... Within 0.2%

Digital input/output Within 0.1%

SN ratio

(Using 22 Hz HPF and 22 kHz LPF)

Analog input/output (Microphone-system, -64 dBu input) 57 dB or more

Analog input/output (Line-system, +4 dBu input) 80 dB or more

Digital input - analog output (full scale reference) 105 dB or more

* The noise level of the analog input/output is measured using the input at 150 Ω termination.

Fader attenuation..... 100 dB or more

(Channel Fader attenuation characteristic for the maximum output level at 8 kHz)

LR phase difference (within transmission frequency range) Within $\pm 2^\circ$

Maximum input level

Analog +23 dBu (Distortion rate within 0.3%)

Digital 0 dB FS (Distortion rate within 0.1%)

6-6 Audio Control Parameters

INPUT LEVEL	
HA GAIN	+10 to -64 dBu (1 dB Step)
TRIM	-24 to +24 dB (1/0.2 dB Step)
INPUT DELAY	
Maximum	5.4 s (1 ms Step)
	(Display switched in frame/m/sample unit)
Minimum adjustment range	1 Audio Sample
Equalizer	
EQ1	Peak/Shelv/Notch
EQ2	Peak
EQ3	Peak
EQ4	Peak/Shelv/Notch
Frequency	20 to 22.4 kHz (245 Point)
Gain	±18 dB (0.2 dB Step)
Q	0.4 to 6.4 (241 Point)
Filter	
FIL1	HPF/Notch/LFE(Surr ch)
FIL2	LPF/Notch
Frequency	12 dB/oct 20 to 22.4 kHz (245 Point)
Frequency (LFE FIL)	24 dB/oct 80/120 Hz
Q (Notch)	0.4 to 6.4 (241 Point)
Dynamics	
PEAK/RMS	0 to 1.0 (101 Point)
COMP	
THRESHOLD	-50 to 0 dB FS (0.25 dB Step)
ATTACK TIME	0.1 mS to 70 mS (125 Point)
RELEASE TIME	10 mS to 2.6 S (133 Point)
RATIO	1.0 to ∞ (253 Point)
KNEE	0 to 1.0 (101 Point)
MAKEUP GAIN	0 to 30 dB (0.125 dB Step)
GATE/EXP	
THRESHOLD	-70 to -10 dB FS (0.25 dB Step)
ATTACK TIME	0.1 mS to 70 mS (125 Point)
RELEASE TIME	70 mS to 2.6 S (125 Point)
RATIO	1.1 to ∞ (23 Point)
RANGE	5 to 80 dB (1.25 dB Step)
HYSTERESIS	0 to 20 dB (0.5 dB Step)
HOLD TIME	70 mS to 2.6 S (125 Point)

7. Exterior Features

7-1 Rear Panel

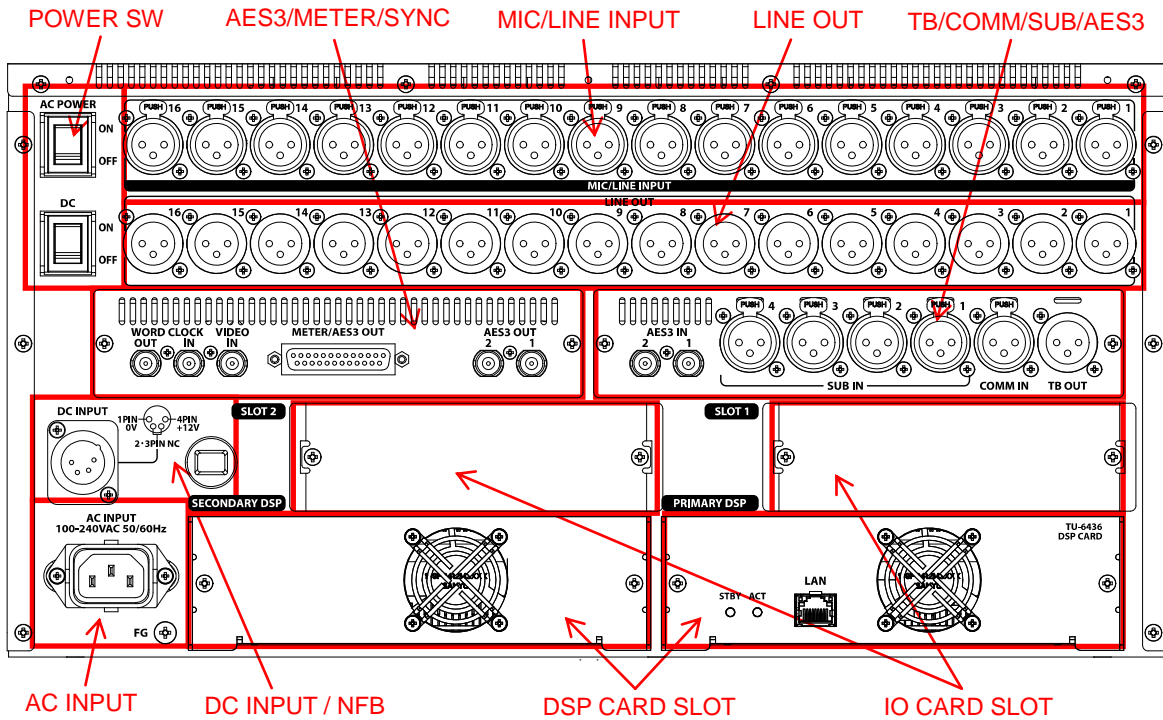

7-1-1 AC INPUT

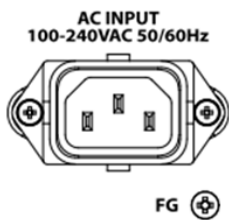

AC Inlet

Connect this terminal to AC power supply. Connect it to AC power supply with the attached AC cable.

FG Terminal

Connect this terminal to ground the enclosure. It need not be connected if the enclosure is grounded via the AC inlet.

7-1-2 DC INPUT/NFB

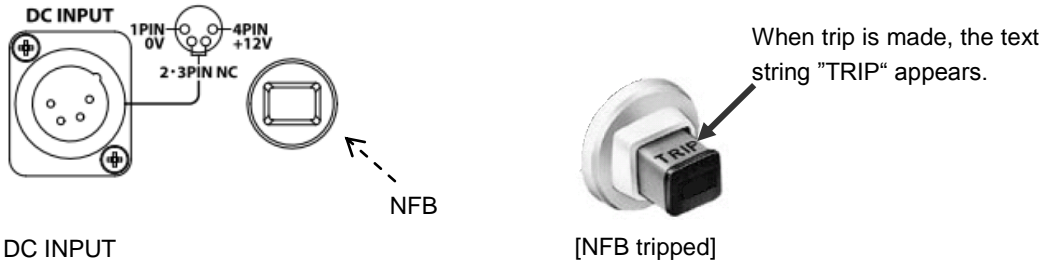

DC INPUT

Connect this terminal to DC power supply.

NFB

No-fuse breaker for DC power security. If an excessive current flows, the square part at the center of the NFB pops up to interrupt the current (tripped). You can restore it by pushing the part. If NFB is tripped, failure may have occurred in the component. Contact our service department or sales representatives.

- * Recommended battery: DUO-C190 (IDX); Lasts for approx. 120 minutes
- * If both AC and DC power supplies are connected, NT110 runs on the power input from AC INPUT. However, a standby current of approx. 250 mA runs on DC INPUT. Be careful of battery exhaustion when a battery is connected.

7-1-3 POWER SW

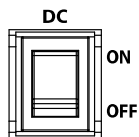
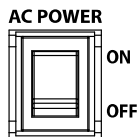

AC POWER

POWER ON/OFF switch of AC power supply

DC

POWER ON/OFF switch of DC power supply

- * NT110 stores all the settings in internal nonvolatile memory. When the NT110 power is turned on, the settings just before the last power-off are restored.

7-1-4 MIC/LINE INPUT

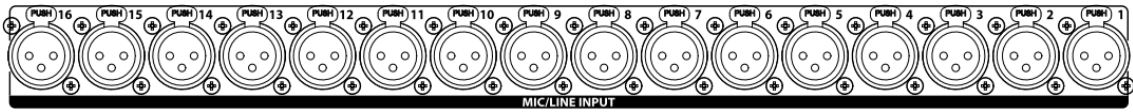

16 ch analog audio input.

You can input microphone-level and line-level audio signals.

Change the input levels on the operation panel.

Turn on/off the P48 (Phantom) power supply on the operation panel.

The supply current capacity of the P48 (Phantom) power supply is 10 mA per channel.

7-1-5 LINE OUT

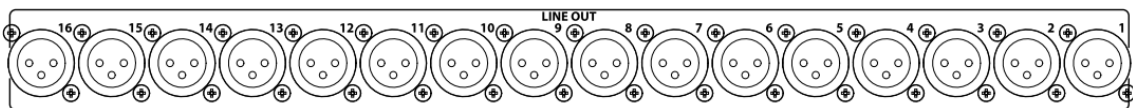

16 ch analog audio output.

The line-level audio is output.

7-1-6 TB/COMM/SUM/AES3

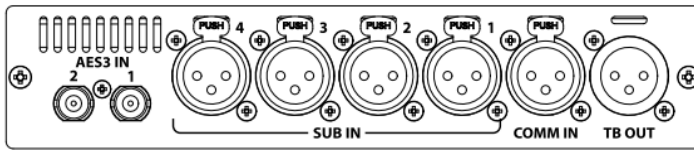

TB OUT

Talkback microphone signals on the operation panel are output at a line level.

COMM IN

Connect intercom signals to this terminal to mix them to the monitor.

DC power of 48 V or less shall be superimposed on intercom signals to be input to this terminal.

Connection of power over 48 V may cause system malfunctions.

SUB IN

4 ch analog audio input.

You can input line-level audio signals. Change the input levels on the operation panel.

AES3 IN

2 ch AES3 id digital audio input.

7-1-7 AES3/METER/SYNC

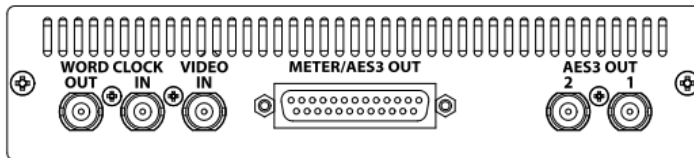

AES3 OUT

2 ch AES3 id digital audio output.

METER/AES3 OUT

4 ch AES3 (110 Ω) digital audio output and control signal input/output.

They can be connected to the meter box or used to take out digital audio signals.

SYNC (VIDEO IN/WORD CLOCK IN/WORD CLOCK OUT)

External synchronization signal input and internal synchronization signal (WORD CLOCK) output.

Select synchronization signals on the operation panel.

7-1-8 IO CARD SLOT

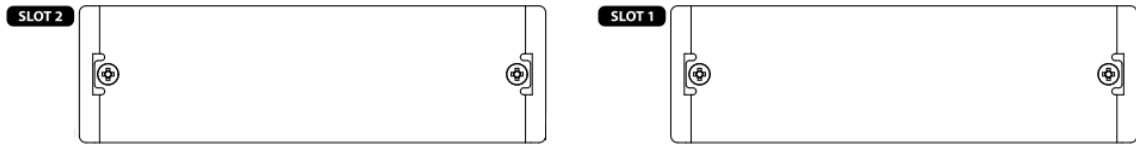

Insert optional IO CARDS of various types to these slots. IO CARDS of different types can be inserted to the slots.

* When CARD of SLOT 1 (2) fails, the card of SLOT 2 (1) may not operate properly as well. Therefore, please remove card of malfunction immediately from the NT110 main unit.

7-1-9 DSP CARD SLOT

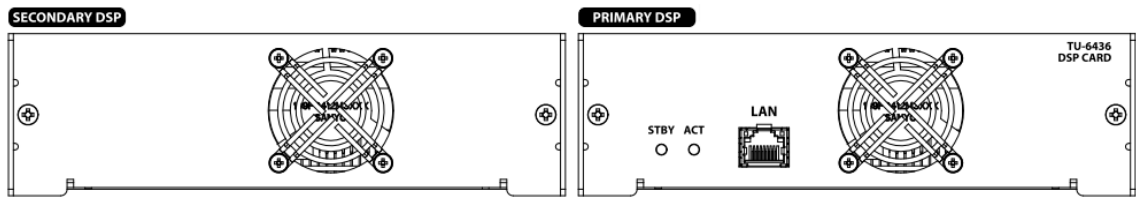

There are two slots for DSP CARDS. By default, one DSP CARD is preinstalled in the PRIMARY DSP slot.

To use redundant configuration of DSP CARDS, mount an additional DSP CARD (optional) in the SECONDARY DSP slot.

7-1-10 Connection of DSP CARDS with NT Mix

To use the NT Mix application, connect DSP CARD(s) to a computer on which the NT Mix application is installed, using a LAN cable of CAT5E or higher.

If Primary DSP is ACT (running), connect with Primary DSP with LAN cable.

If the Secondary DSP is ACT (running), connect with the secondary DSP with a LAN cable.

Note: Connect a DSP CARD with a computer directly, not via any external equipment such as a hub.

Note: If the DSP CARD is composed of two boards and the DSP CARD of the ACT switches from Primary to Secondary, it is necessary to change the connection of the LAN cable.

[Connection with a NT Mix: One DSP CARD configuration]

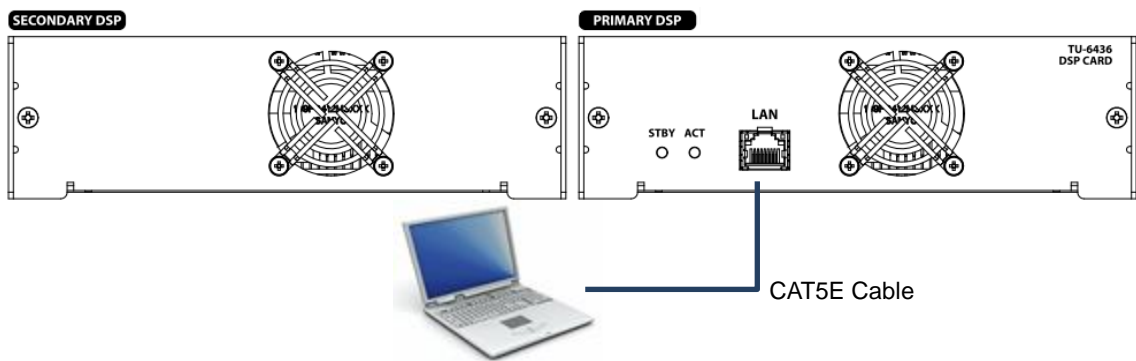

[Connection with a NT Mix: Two DSP CARD configuration Primary DSP CARD = ACT]

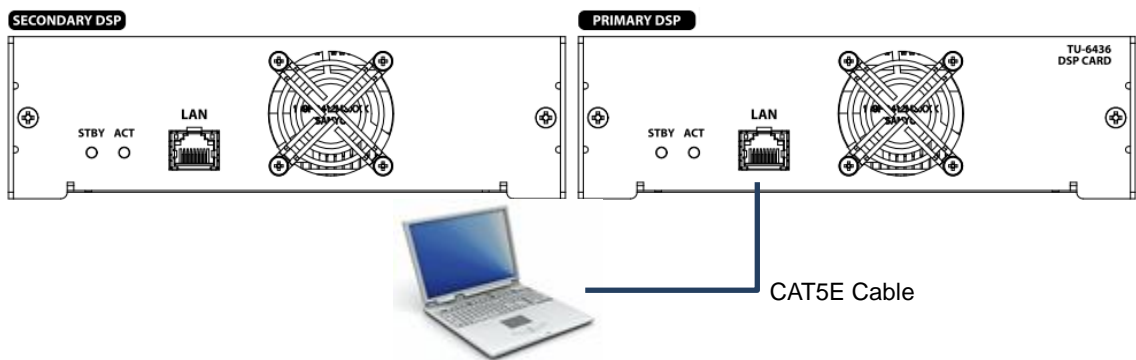

[Connection with a NT Mix: Two DSP CARD configuration Secondary DSP CARD = ACT]

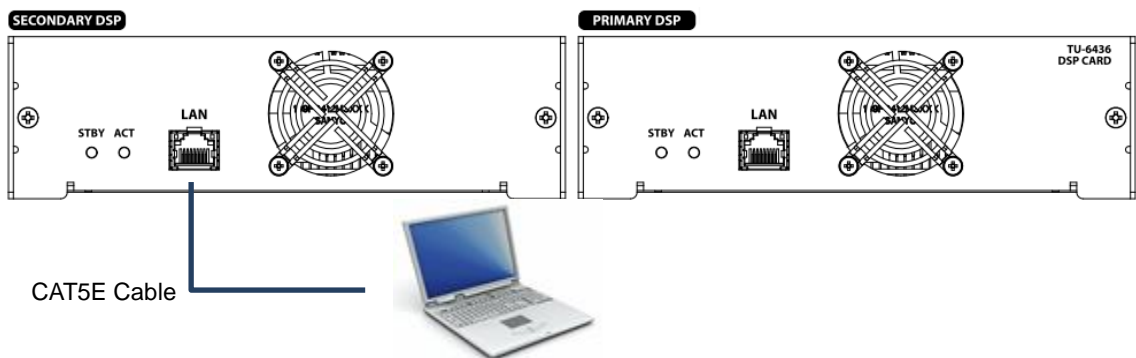

7-2 Front Panel

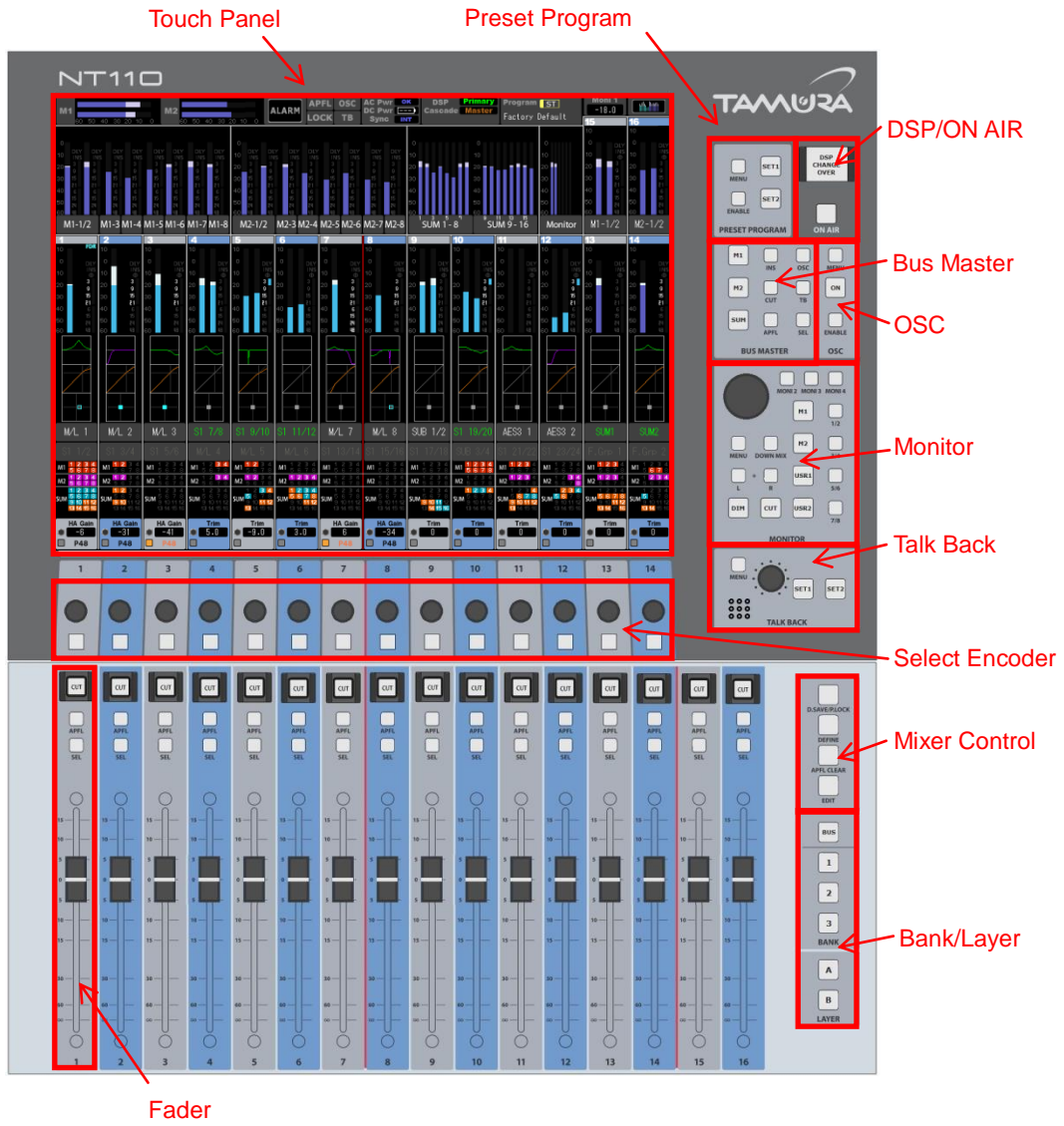

7-2-1 Touch Panel

The touch panel displays the audio meter, channel settings, etc. It also allows you to make various settings of mixers with touch panel operation.

7-2-2 Preset Program

Perform various controls of the Preset Program (function to store and recall mixer settings to and from the internal memory).

The Preset Program memory has a capacity for storing 99 mixer settings.

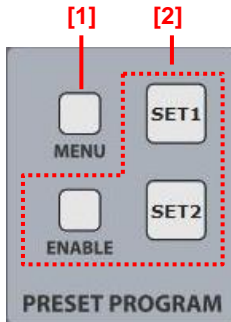

[1] MENU

Displays the Preset Program menu on the touch panel. After displaying the menu, press it again to return to the Meter screen.

[2] SET1/SET2/ENABLE

Press and hold the Set1 button while pressing the ENABLE button to recall Preset Program No.1.

Press and hold the Set2 button while pressing the ENABLE button to recall Preset Program No.2.

7-2-3 DSP/On Air

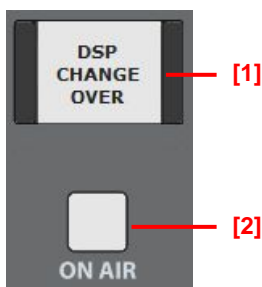

[1] DSP CHANGE OVER

If DSP CARDS are in a redundant configuration, press this button to activate the DSP CARD mounted in the Secondary DSP Slot.

If DSP Auto Changeover is set to Enable in the Setup menu, the DSP CARD is automatically switched. In this case, this button is used to forcibly select the DSP CARD mounted in the Secondary DSP Slot.

[2] ON AIR

Press this button to set the mixer to ON AIR.

In the ON AIR status, a function selected in the Config menu (prohibiting OSC or Talk Back transmission, etc.) starts working.

7-2-4 Bus Master

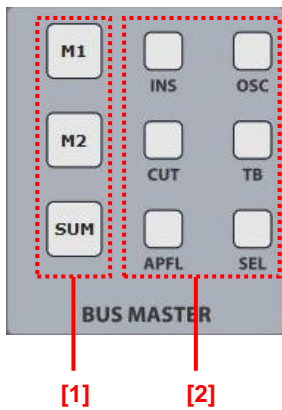

- [1] **M1/M2/SUM**
 Recall Bus Master to Select Encoder.
 Operate Select Encoder to adjust the Fader Level of Bus Master.
- [2] **INS/CUT/APFL/OSC/TB/SEL**
 Press one of these buttons to switch the button functions of Select Encoder.

7-2-5 OSC

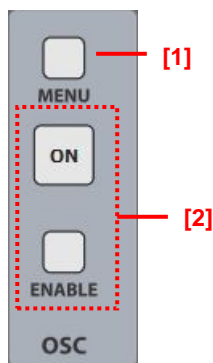

- [1] **MENU**
 Display the OSC menu on the touch panel.
 After displaying the menu, press it again to return to the Meter screen.
- [2] **ON / ENABLE**
 Press the ON button while pressing the Enable button to have OSC interrupt the output selected as OSC Set (Preset).
 The ON button is lit while OSC interrupts any of the outputs.
 Press the lit ON button to cancel all the OSC interruptions.

7-2-6 Monitor

Perform various controls of Monitors 1 to 4.

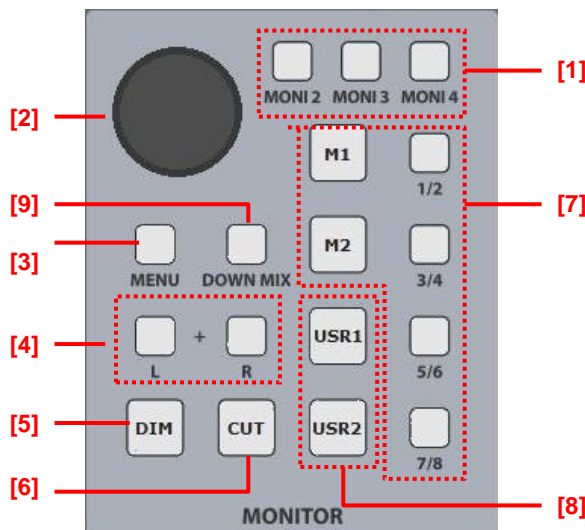

- [1] **MONI2 / MONI3 / MONI4**
 Select a monitor that you want to control. Only one of these buttons can be selected. When all the buttons are off, Moni1 is selected.

-
- [2] **Monitor volume (Encoder)**
Adjust the monitor volume. The volume level is displayed as a numeric value on the upper right corner on the touch panel.
You can push and turn it to fine-tune the level.
- [3] **MENU**
Displays the Monitor menu on the touch panel.
After displaying the menu, press it again to return to the Meter screen.
- [4] **L/R**
Perform L and R branching. Turn on both the L and R buttons to perform L+R branching.
- [5] **DIM**
Turn on/off Dimmer. The volume is reduced. Set the Dimmer Level in the Monitor menu on the touch panel.
- [6] **CUT**
Turn on/off Cut. Audio is muted when Cut is on.
- [7] **M1/M2, 1/2, 3/4, 5/6, 7/8**
Select M1/M2 monitor source. Selecting a combination of the M1/M2 button and the 1/2, 3/4, 5/6, or 7/8 button selects a source.
Example: If the M1 and 1/2 buttons are on, Master1-1/2 source is selected.
* You can select a monaural source by combining them with the L/R button.
Pressing the other button while holding down the first button from NT110 main unit panel button (M1, M2, USR1, USR2 or 1/2, 3/4, 5/6, 7/8) causes Monitor Mix the function is enabled.
-

Selection of a monitor source using a combination of M1/M2 and 1/2, 3/4, 5/6, or 7/8 buttons

Button selection		Console Mode			
		Stereo		5.1 Surr	
M1/M2	1- 8	RESOURCE	FORMAT	RESOURCE	FORMAT
M1	OFF	M1 1/2	ST	M1 1 - 6	5.1
	1/2	M1 1/2	ST	M1 1/2	ST
	3/4	M1 3/4	ST	M1 3/4	ST
	5/6	M1 5/6	ST	M1 5/6	ST
	7/8	M1 7/8	ST	M1 7/8	ST
M2	OFF	M2 1/2	ST	M2 1 - 6	5.1
	1/2	M2 1/2	ST	M2 1/2	ST
	3/4	M2 3/4	ST	M2 3/4	ST
	5/6	M2 5/6	ST	M2 5/6	ST
	7/8	M2 7/8	ST	M2 7/8	ST

- [8] **USR1 / USR2**
Select a monitor source specified as User Source 1 or 2. Set the User Sources in the Monitor menu on the touch panel.
- [9] **DOWN MIX**
Turn on this button to downmix surround sources and monitor them.

7-2-7 Talk Back

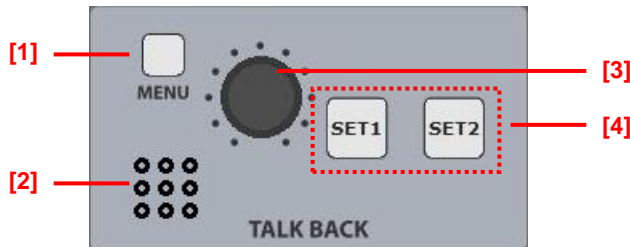

- [1] **MENU**
Display the TB (Talk Back) menu on the touch panel. After displaying the menu, press it again to return to the Meter screen.
- [2] **Built-in microphone**
A built-in microphone for talkback is provided. Audio input from this microphone are converted to talkback audio signals.
- [3] **Talkback volume**
Adjust the talkback volume.
- [4] **SET1/SET2**
Press the Set1 button to have TB interrupt the output selected as TB Set1 (Preset1). Press the Set2 button to have TB interrupt the output selected as TB Set2 (Preset2).

7-2-8 Mixer Control

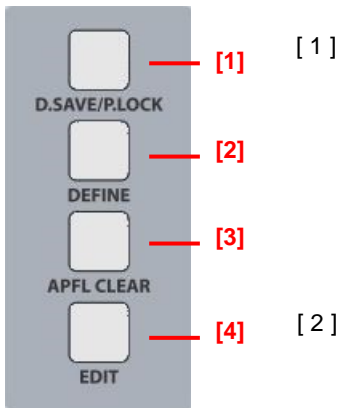

D.SAVE/P.LOCK

Press this button to enter the Display Save status in which the touch panel goes off. Press this button again to exit the status.

Press and hold this button to lock the operations on the panel except using this button. Press this button again to exit the status.

DEFINE

Select Encoder can be assigned to any user-specified function. (Define)

Press this button to switch Select Encoder only for the assigned channel to the Define function.

When you press a desired Select Encoder while pressing this button in the Channel Setting screen, it is defined as the Define function of that channel.

APFL CLEAR

This button is lit when at least one of the APFL buttons is on. Press this button while it is lit to deselect all the APFL buttons.

EDIT

Display the Edit menu on the touch panel.

The Edit menu allows you to copy and clear the channel parameters.

7-2-9 Bank/Layer

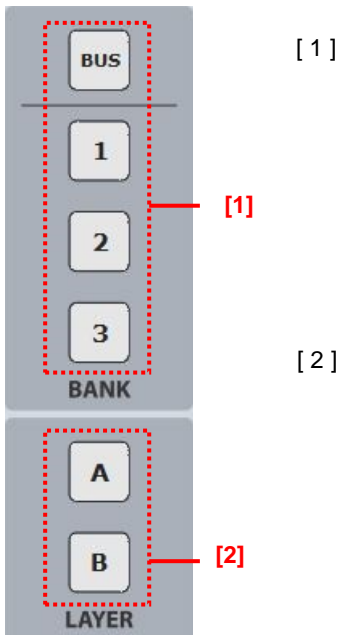

BANK1/2/3/BUS

Switch the Fader 16 ch Banks.

There are three Banks for which the user can freely configure the layout: Bank1, Bank2, and Bank3. Each of the Banks has two layers (A/B).

Selecting the Bus switches the Fader 16 ch Banks to the Bus. The Bus Bank has two layers: Layer A fixed to M1 and M2 and Layer B fixed to Sum.

LAYER A/B

Switch the Fader 16 ch Layers.

Press this button to switch the all Fader 16 ch Layers simultaneously.

Press the Fader Sel button while pressing this button to switch Layers for each channel.

7-2-10 Select Encoder

These are encoders and buttons with functions that switch for each application. By default, they serve as the HA Gain/Trim encoders.

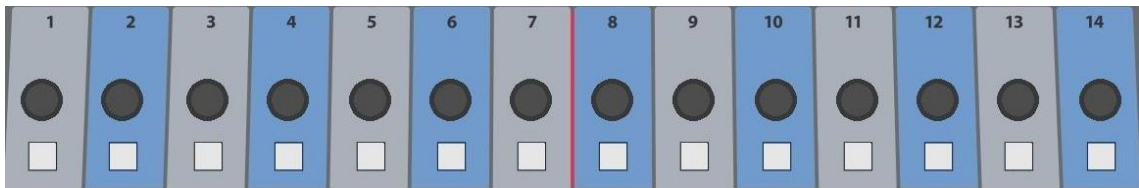

For some of the assigned functions, you can fine-tune them by rotating an encoder while pressing it.

7-2-11 Fader

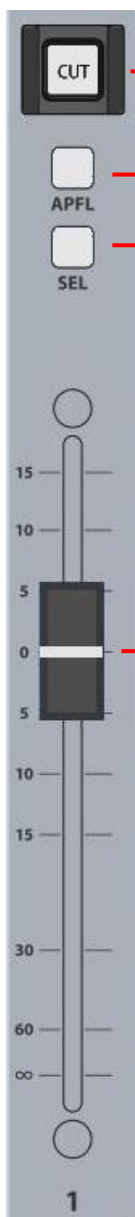

- [1] **CUT**
Turn on/off Cut. Signals of the channel are muted when Cut is on.
- [2] **APFL**
Turn on/off APFL. When it is on, channel signals are sent to the APFL Bus and interrupts the Monitor specified in the Config menu.
APFL is turned on and off every time this button is pressed. In this case, AFL signals are sent to the APFL Bus.
Press and hold this button to send PFL signals to the APFL Bus while it is pressed.
- [3] **SEL**
Normally, press this button to recall the Channel Setting screen on the touch panel and set Select Encoder to the Channel Setting function.
Channel Setting is a mode for adjusting all the parameters of a channel. When all the parameters are displayed on the touch panel, use Select Encoder to adjust the parameters.
* The Sel button serves as a function for specifying a channel in a special mode other than the above.
- [4] **Fader**
Motor fader with a 100 mm stroke. Adjust the master volume of a channel.

7-3 Headphone Panel

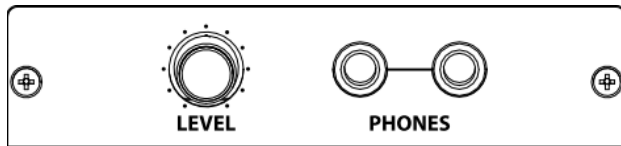

The headphone panel is located in the forefront lower part of the mixer faders.

There are two headphone jacks to each of which you can connect a headphone. (The two jacks output the same audio.)

Select output signals of a headphone in the Out Mtx menu on the touch panel.

If you set Monitor as output signals to a headphone using the Out Mtx function, the headphone audio can be linked to the Monitor source selection.

8. Connector Pin List

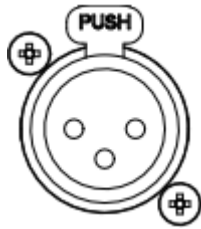

Connector : XLR 3-31 (f)

Pin#1	Shield
Pin#2	Hot
Pin#3	Cold

MIC/LINE INPUT

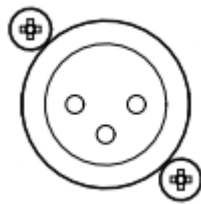

Connector : XLR3-32 (m)

Pin#1	Shield
Pin#2	Hot
Pin#3	Cold

LINE OUT

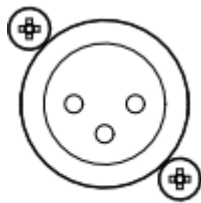

Connector : XLR3-32 (m)

Pin#1	Shield
Pin#2	Hot
Pin#3	Cold

TB OUT

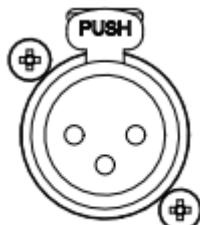

Connector : XLR3-31 (f)

Pin#1	Shield
Pin#2	Hot
Pin#3	Cold

COMM IN

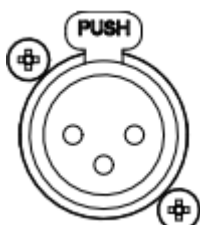

Connector : XLR3-31 (f)

Pin#1	Shield
Pin#2	Hot
Pin#3	Cold

SUB IN

METER/AES3 OUT

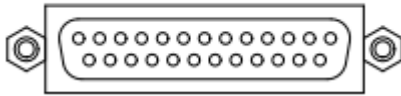

Connector: DB25S(f), Locking screw M2.6x0.45

Pin#1	AES3 OUT4 Hot	Pin#14	AES3 OUT4 Cold
Pin#2	AES3 OUT4 Shield	Pin#15	AES3 OUT3 Hot
Pin#3	AES3 OUT3 Cold	Pin#16	AES3 OUT3 Shield
Pin#4	AES3 OUT2 Hot	Pin#17	AES3 OUT2 Cold
Pin#5	AES3 OUT2 Shield	Pin#18	AES3 OUT1 Hot
Pin#6	AES3 OUT1 Cold	Pin#19	AES3 OUT1 Shield
Pin#7		Pin#20	
Pin#8	Gnd	Pin#21	
Pin#9	RS422 Tx (+)	Pin#22	Gnd
Pin#10	RS422 Rx (+)	Pin#23	
Pin#11	Gnd	Pin#24	
Pin#12	RS422 Rx (-)	Pin#25	Gnd
Pin#13	RS422 Tx (-)		

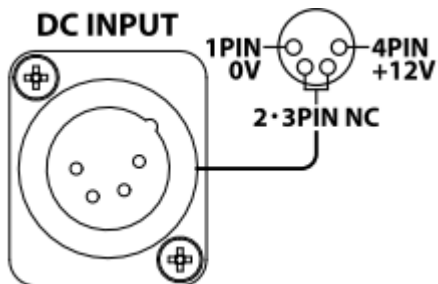

Connector : XLR4-32 (m)

Pin#1	0V (Gnd)
Pin#2	
Pin#3	
Pin#4	+12V

9. Outline Drawing

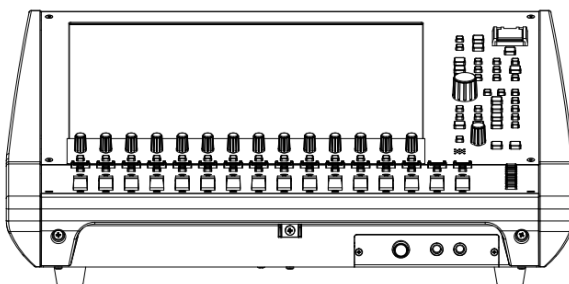
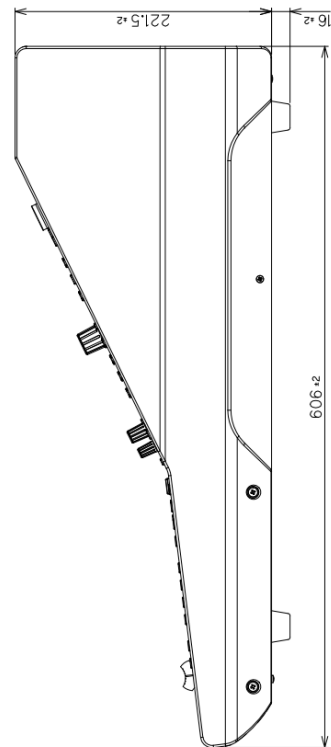
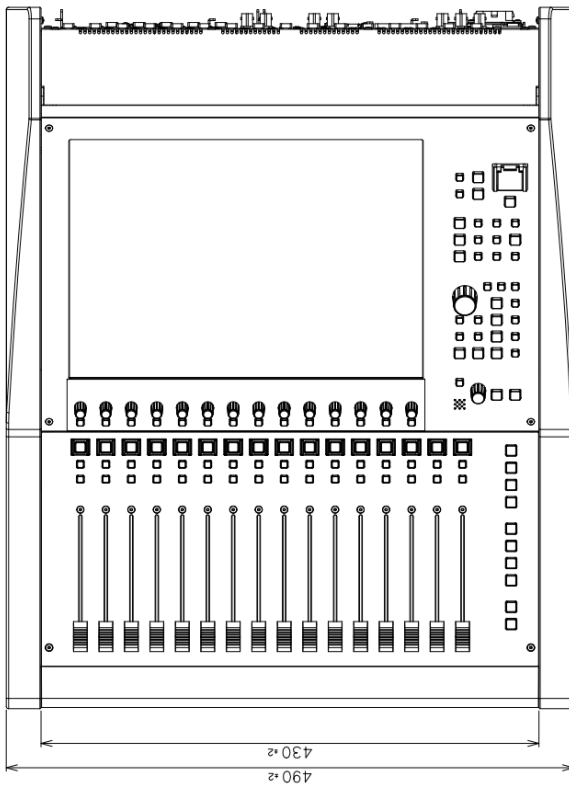
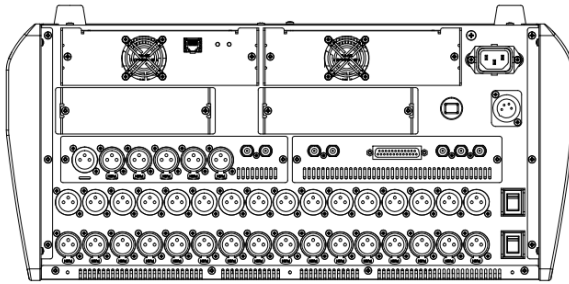

10. Appendix

10-1 Adding DSP CARD

10-1-1 Precautions



If two DSP CARD configuration is used, the same-version DSP CARDS must be mounted in the Primary DSP Slot and the Secondary DSP Slot.



The involatile memory of a DSP CARD stores the Setup and Preset Program data. The stored data may be lost if you perform a replacement procedure incorrectly or the DSP CARD fails. If a means for emergency recovery is required, it is recommended to perform "Backup of NT110 Data." For the details of the procedure, refer to Appendix, Backing Up and Uploading NT110 Data.



Dissipate the static electricity from your body sufficiently before you touch anywhere DSP CARDS.

10-1-2 Additional Procedure

* This procedure copies the data stored in the Primary DSP CARD (Setup and Preset Program) to a new DSP CARD mounted in the Secondary DSP Slot.



Please keep the removed FAN CARD carefully. Fan card is necessary to restore the original state, such as when DSP CARD fails.

1 Turn off the NT110 power.

2 Remove FAN CARD and install DSP CARD.

3 Before turning on the NT110 power, make sure that the DSP Change Over button located at the upper right side of the touch panel is Off (not depressed).

Make sure that the button is not depressed and is in the Off status. The data stored in the Primary DSP CARD will be lost if the button is depressed and is in the On status.

4 Turn on the NT110 power.

While the startup screen is displayed, data is transferred from the Primary DSP CARD to the Secondary DSP CARD.

10-1-3 Operation Check after Adding

After adding, activate the DSP CARD to check the audio input/output and operation displays.

s

10-2 Replacing DSP CARD

10-2-1 Precautions



If two DSP CARD configuration is used, the same-version DSP CARDS must be mounted in the Primary DSP Slot and the Secondary DSP Slot.



The involatile memory of a DSP CARD stores the Setup and Preset Program data. The stored data may be lost if you perform a replacement procedure incorrectly or the DSP CARD fails. If a means for emergency recovery is required, it is recommended to perform "Backup of NT110 Data." For the details of the procedure, refer to Appendix, Backing Up and Uploading NT110 Data.



Dissipate the static electricity from your body sufficiently before you touch anywhere DSP CARDS.

10-2-2 One DSP CARD Configuration

- * Perform Procedures 1 and 5 if you need to transfer the data stored in a DSP CARD (Setup and Preset Program) to a new DSP CARD.
- * To transfer only the Setup settings stored in a DSP CARD, you can record the Setup settings before replacement and manually configure the Setup settings after replacement. In this case, you need not perform Procedures 1 and 5.

1 Perform the procedure of "Transferring Data from NT110 to PC."

For details of the procedure, refer to Appendix, Transferring Backup Data from NT110 to PC File (Backup).

2 Turn off the NT110 power.

3 Remove the DSP CARD to be replaced and install a new DSP CARD.

4 Turn on the NT110 power.

5 Perform the procedure of "Transferring Data from PC File to NT110."

For details of the procedure, refer to Appendix, Transferring Backup Data from PC File to NT110 (Upload).

10-2-3 Two DSP CARD Configuration (Replacing Primary DSP CARD)

* This procedure copies the data stored in the Secondary DSP CARD (Setup and Preset Program) to a new DSP CARD mounted in the Primary DSP Slot.



If loss of data in the DSP CARD is critical, it is recommended to perform "Backup of NT110 Data" to provide a means for emergency recovery. For the details of the procedure, refer to Appendix, Backing Up and Uploading NT110 Data.

1 Turn off the NT110 power.

2 Remove the DSP CARD to be replaced and install a new DSP CARD.

3 Before turning on the NT110 power, press the DSP Change Over button located at the upper right side of the touch panel to turn it on.

Make sure that the button is depressed and is in the On status. The data stored in the Secondary DSP CARD will be lost if the button is not depressed and is in the Off status.

4 Turn on the NT110 power.

While the startup screen is displayed, data is transferred from the Secondary DSP CARD to the Primary DSP CARD.

5 After the normal screen of NT110 appears, press the DSP Change Over button again to turn it off.

10-2-4 Two DSP CARD Configuration (Replacing Secondary DSP CARD)

* This procedure copies the data stored in the Primary DSP CARD (Setup and Preset Program) to a new DSP CARD mounted in the Secondary DSP Slot.



If loss of data in the DSP CARD is critical, it is recommended to perform "Backup of NT110 Data" to provide a means for emergency recovery. For the details of the procedure, refer to Appendix, Backing Up and Uploading NT110 Data.

1 Turn off the NT110 power.

2 Remove the DSP CARD to be replaced and install a new DSP CARD.

3 Before turning on the NT110 power, make sure that the DSP Change Over button located at the upper right side of the touch panel is Off (not depressed).

Make sure that the button is not depressed and is in the Off status. The data stored in the Primary DSP CARD will be lost if the button is depressed and is in the On status.

4 Turn on the NT110 power.

While the startup screen is displayed, data is transferred from the Primary DSP CARD to the Secondary DSP CARD.

10-2-5 Operation Check after Replacement

After replacement, activate the DSP CARD to check the audio input/output and operation displays.

10-3 DSP CARD Installation Method

Install DSP CARD in the following procedure.

* Dissipate the static electricity from your body sufficiently before you touch anywhere CARDS.

10-3-1 Remove DSP CARD (FAN CARD)

Remove the two screws from the DSP CARD as shown in the figure below.

*The figure shows DSP CARD removal on the PRIMARY DSP side.

* Removal of SECONDARY DSP side or FAN CARD is the same procedure.

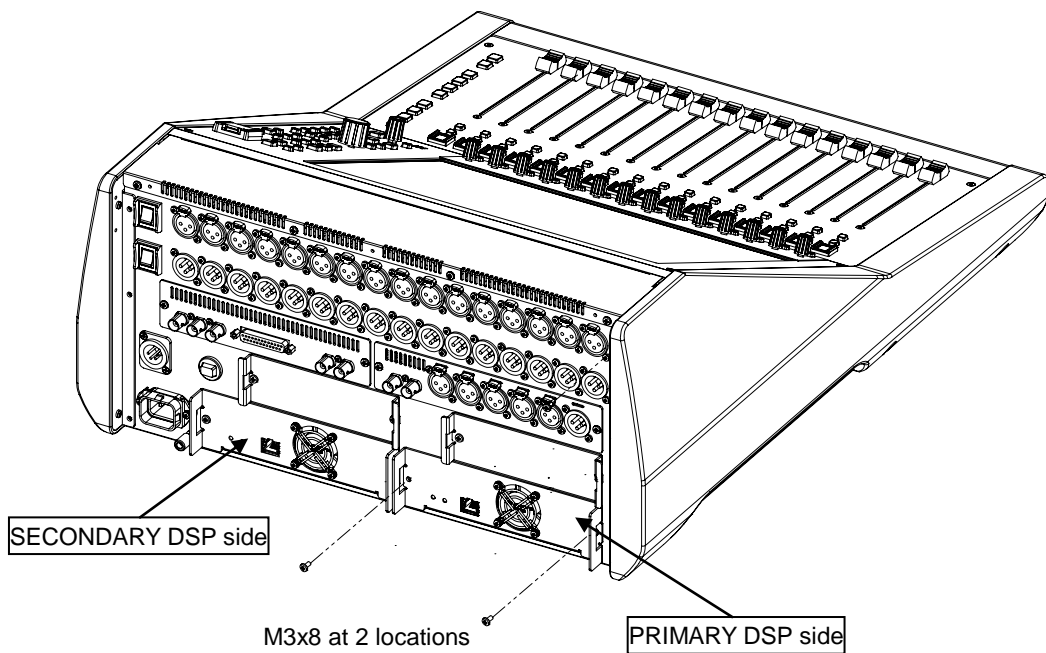

Grasp both sides (red circle in the figure below) of DSP CARD and pull it toward you, DSP CARD will come off the main unit.

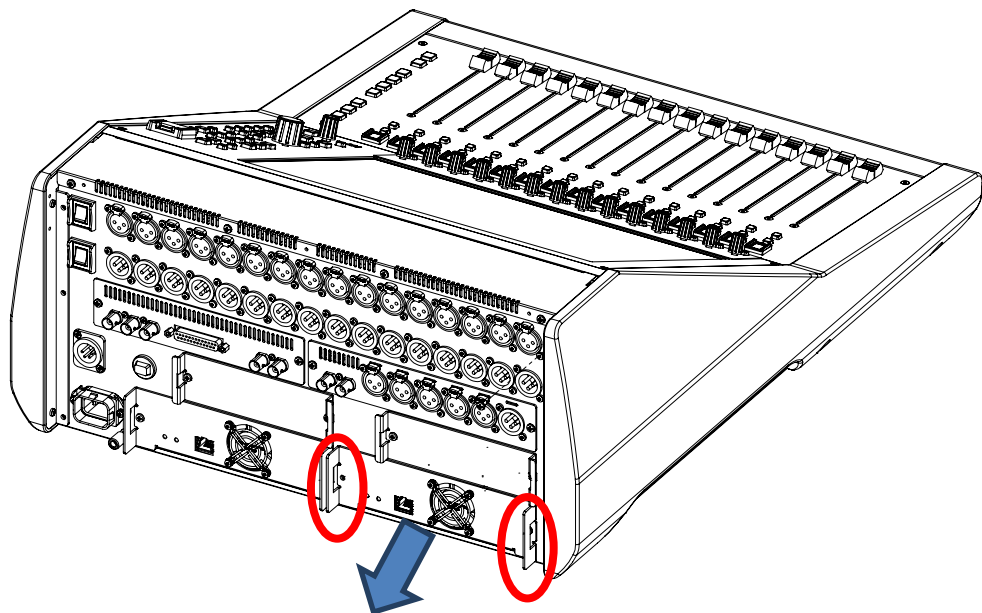

10-3-2 Install DSP CARD

Insert the DSP CARD straight and tighten the two places with the screw as shown in the figure below.

* If the mounting of the screw is loose, you do not can use it in the correct state. Because the electrical signal level is not stable.

* The figure shows DSP CARD installation on the PRIMARY DSP side.

* SECONDARY DSP side and FAN CARD installation is the same procedure.

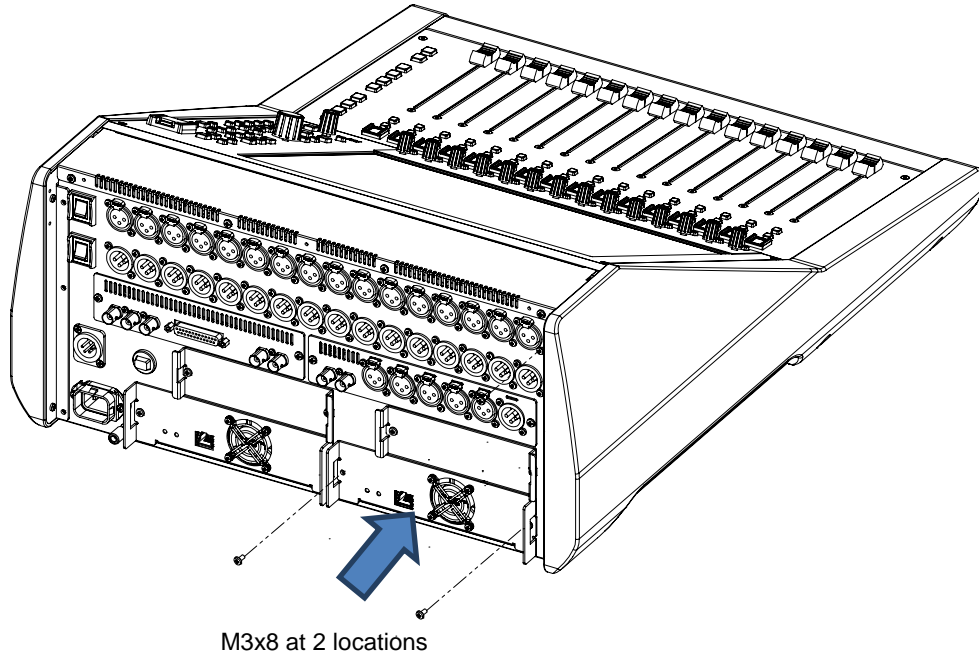

10-4 IO CARD Installation Method

Install IO CARD in the following procedure.

* Dissipate the static electricity from your body sufficiently before you touch anywhere CARDS.

10-4-1 Removing Blank Panel

Remove the two screws from the Blank Panel as shown in the figure below.

*The figure shows the IO CARD mounting on the SLOT1 side.

* Removing the SLOT 2 side is the same procedure.

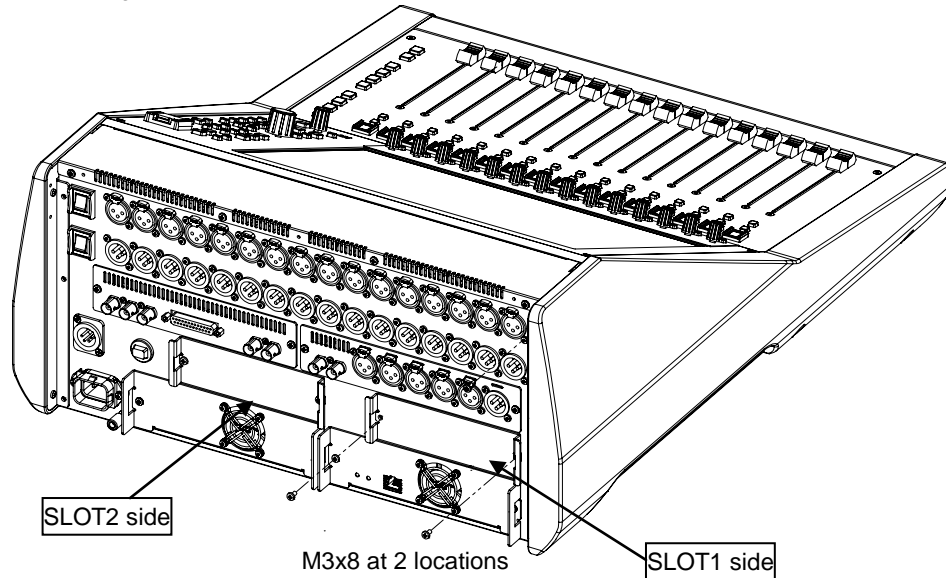

The blank panel will come off.

10-4-2 Install IO CARD

Insert the IO CARD straight and tighten the two places with the screw as shown in the figure below.

* If the mounting of the screw is loose, you do not can use it in the correct state. Because the electrical signal level is not stable.

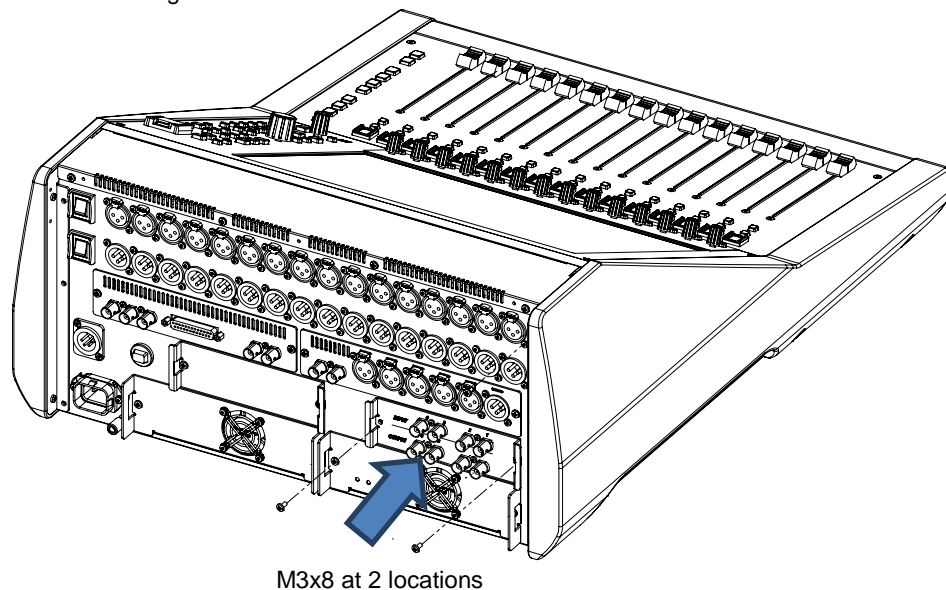

10-5 Removing Exterior Equipment (Side Panels and Pad)

10-5-1 Removing Side Panels

Remove the six screws from the rear panel as shown in the figure below.

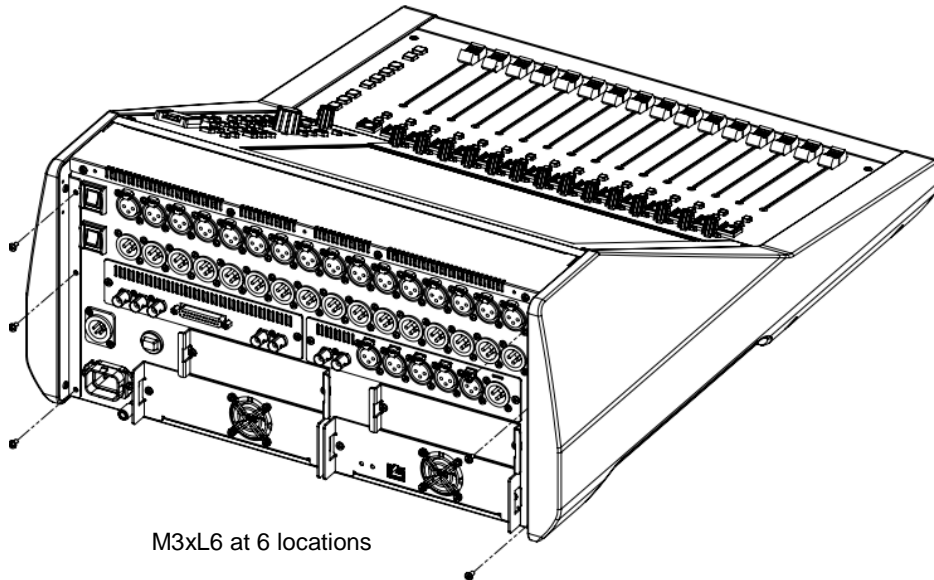

Remove the two screws from each of the side panels as shown in the figure below. Slide the side panels downward to detach them from the main unit.

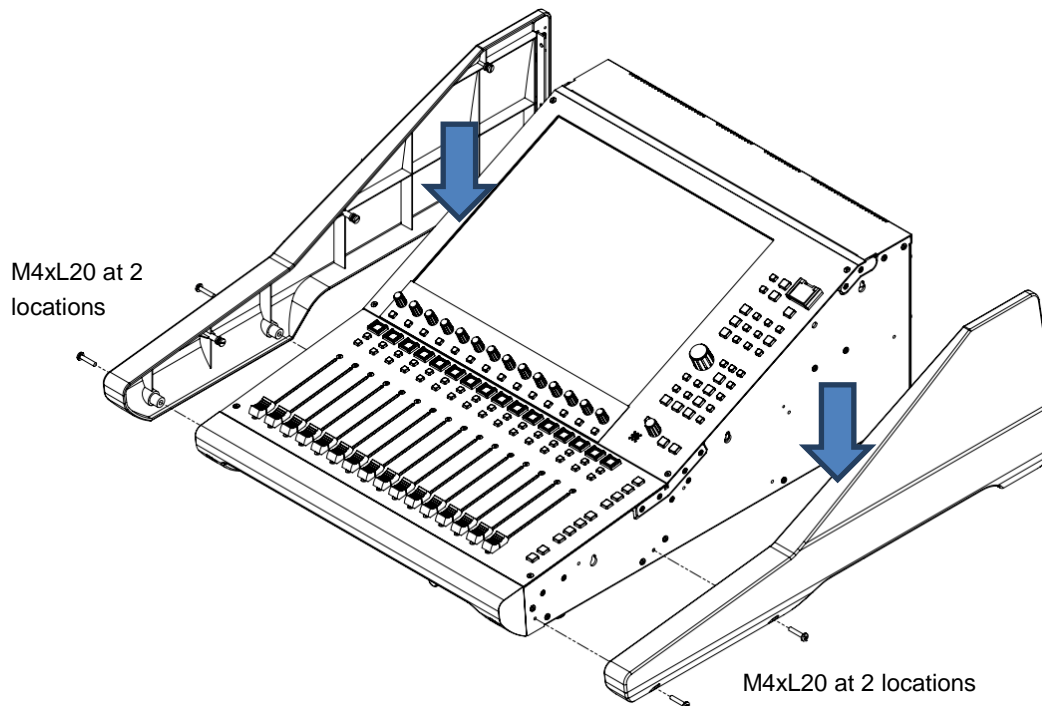

10-5-2 Removing Pad

Remove the three screws from the front part as shown in the figure below. The pad is detached from the main unit.

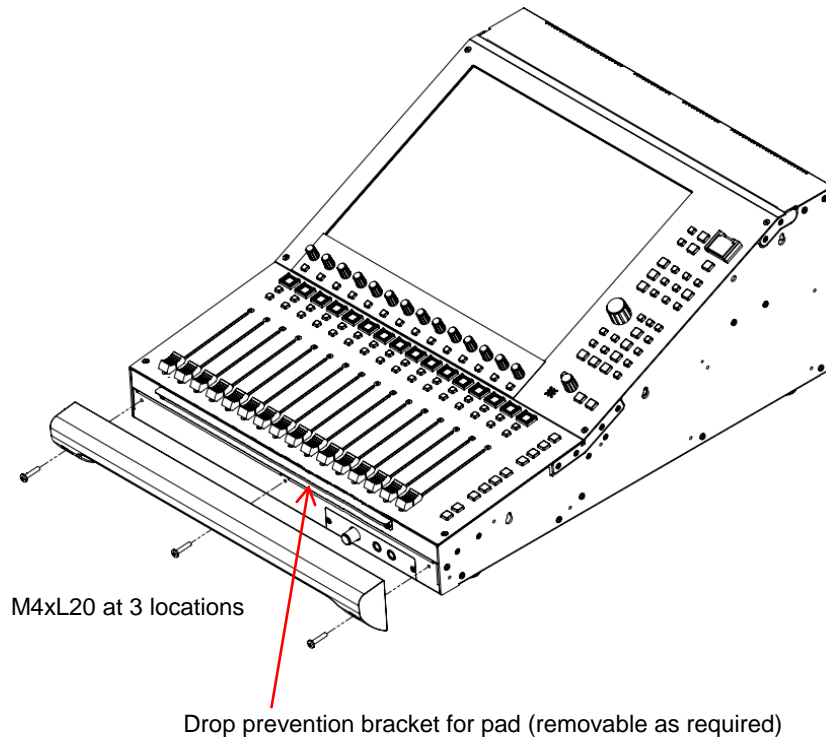

10-6 About Fixing Screw Holes

After the side panels in the exterior equipment are removed, NT110 can be fixed using the screw holes on the sides.

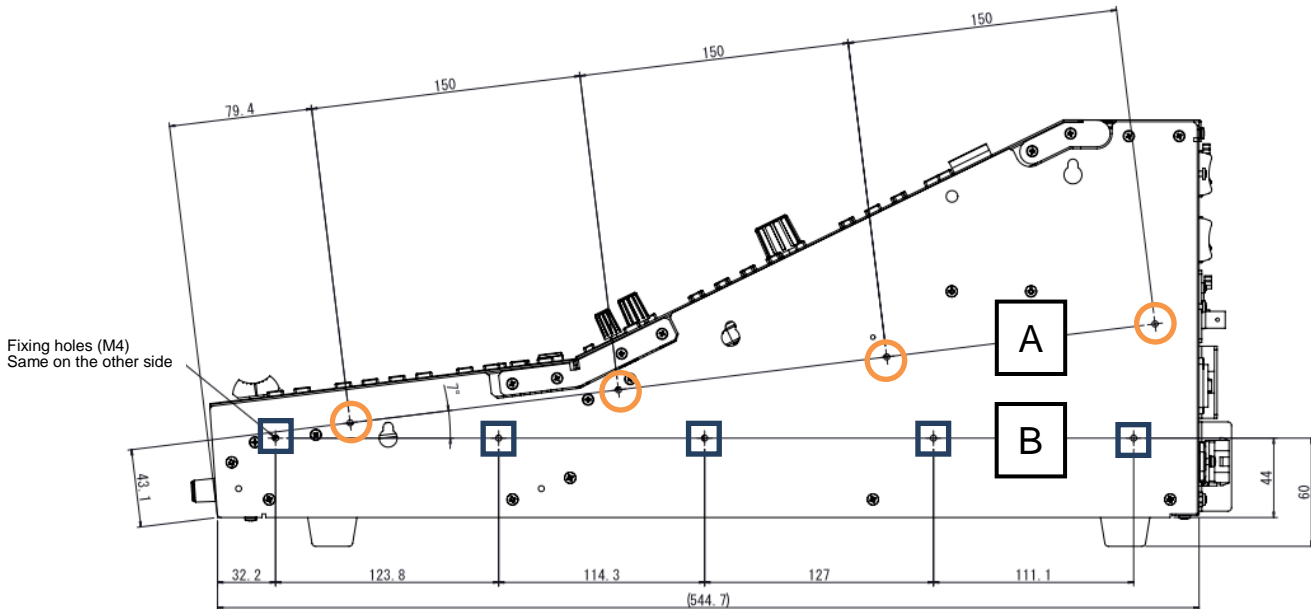

10-6-1 Four Fixing Screw Holes at A

These screw holes are provided to mount optional mounting brackets. Mounting brackets are used to fix NT110 to a tilt rack or embed it in a table.

* Refer also to the instruction manual of mounting brackets.

10-6-2 Five Fixing Screw Holes at B

These screw holes are provided to mount slide rails.

Recommended slide rails

- Slide rail C-305-20 Settsu Metal Industrial Co., Ltd. * Set of two slide rails
- Slide rail bracket RBA2-35-200E Settsu Metal Industrial Co., Ltd. * For EIA standard racks

Precautions on use

- 1) Use "Binding head screws M4xL6" to install slide rails on NT110. Do not use any other screws. If you use any other screws, NT110 may drop off from the rails or cause system malfunctions due to a short-circuit of internal circuits in the system.
- 2) After you install slide rails on NT110 and mount it on a rack, do not put any heavy object on NT110 or lean on it while operating it. If any load exceeding the withstand load is applied, the rails or other part may be damaged.
- 3) Although the recommended slide rail has a mechanism to lock the slider when the unit is pulled out, it does not have any mechanism to lock the slider when the unit is pushed in. You need to supply a lock mechanism for yourself if required.

10-7 How to Install Accessory Sunshade

When installing the accessory sunshade, reflection of outside light on NT110 operation surface will be less. When it is difficult to see the display on the operation panel in a bright place, please use the accessory sunshade.

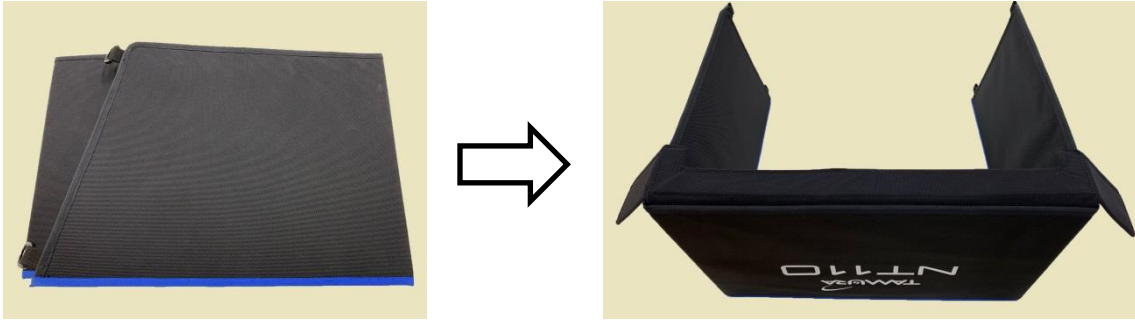

① Spread the folded sunshade

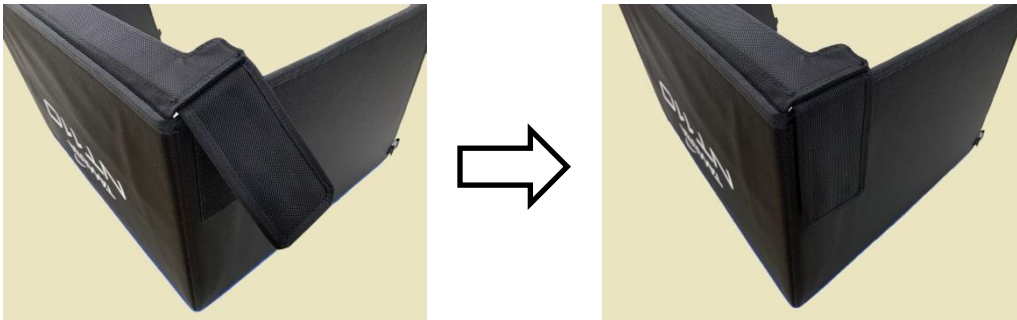

② Paste the left and right Velcro



③ Install it so that it covers NT110 body as shown above

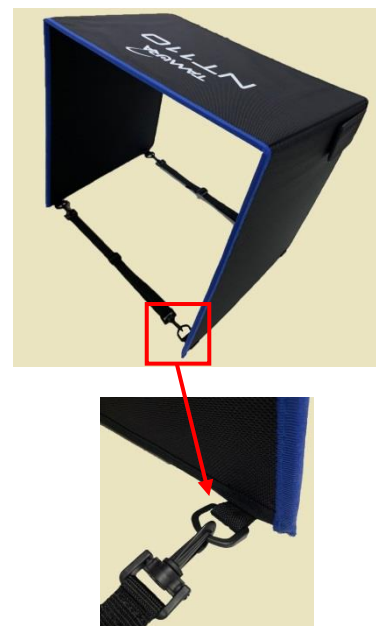

After installing the two strings through the Bottom, You can prevent sunshade from being blown by the wind.

10-8 Initializing Internal Data

Perform the following procedure to initialize internal data when required.

If NT110 does not start up due to an internal data error, you may be able to clear the error using this procedure.

* Data to be initialized by this procedure

- All the program settings such as the fader layouts, output matrixes, and EQ parameters
- SETUP setting data (Data configured in the SETUP menu)

* Data NOT to be initialized by this procedure

- PRESET PROGRAM (01 to 99) data
- Log record data

1 Turn on the NT110 power.

2 Before the NT screen is displayed during startup, keep pressing the four buttons, LAYER "A" and "B" and PRESET PROGRAM "MENU" and "ENABLE" until the NT110 Initialize message is displayed.



NT screen



Keep pressing LAYER "A" and "B" and PRESET PROGRAM "MENU" and "ENABLE."

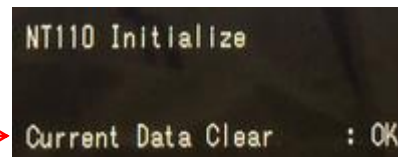
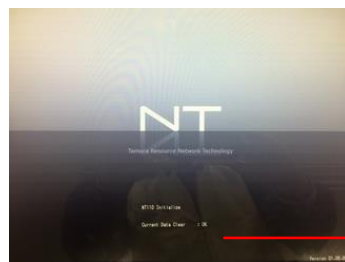

Caution: Never turn off the power until the startup is normally completed when the Meter screen is displayed.

3 The internal data initialization is completed when the Meter screen is displayed.

10-9 Backing Up and Uploading NT110 Data

Have ready a PC on which NT110 NT Mix has been installed.

10-9-1 Transferring Backup Data from NT110 to PC File (Backup)

- 1 Connect the DSP CARD and the PC with a LAN cable.**
 If two DSP CARDS are mounted, connect the cable to the ACT(running) DSP CARD.
 (If the Primary DSP CARD is Active, connect the cable to the Primary DSP CARD; If the Secondary DSP CARD is Active, connect the cable to the Secondary DSP CARD.)
- 2 Turn on the NT110 power.**
- 3 Start up NT110 NT Mix that has been installed on the PC.**
- 4 Connect NT110 NT Mix.**

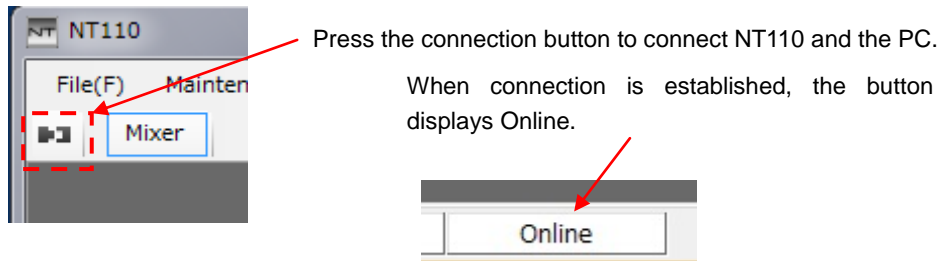

- 5 On NT110 NT Mix, select Maintenance - Mixer Data - Backup.**

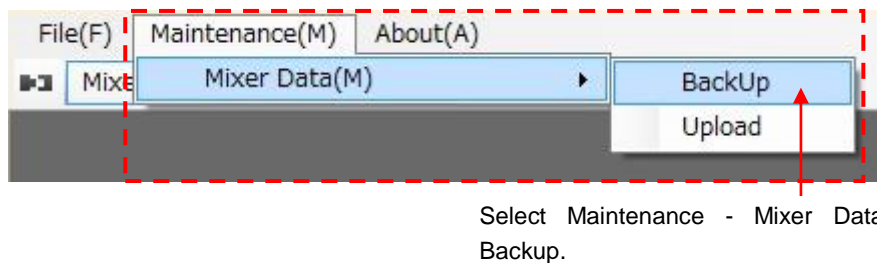

- 6 Using the displayed dialog, select any folder and press the Backup button.**
 Data is transferred from NT110 to a file in the selected folder. This process takes some time. Wait until it is completed.
 The stored file contains setting (including Setup setting) and all the Preset Program files of NT110.

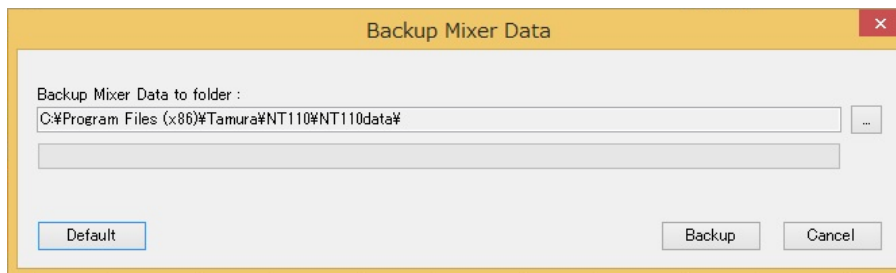

10-9-2 Transferring Backup Data from PC File to NT110 (Upload)

- 1 Connect the DSP CARD and the PC with a LAN cable.**
 If two DSP CARDS are mounted, connect the cable to the ACT(running) DSP CARD.
 (If the Primary DSP CARD is Active, connect the cable to the Primary DSP CARD; If the Secondary DSP CARD is Active, connect the cable to the Secondary DSP CARD.)
- 2 Turn on the NT110 power.**
- 3 Start up NT110 NT Mix that has been installed on the PC.**
- 4 Connect NT110 NT Mix.**

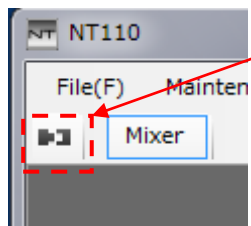

Press the connection button to connect NT110 and the PC.

When connection is established, the button displays Online.

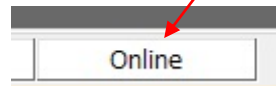

- 5 On NT110 NT Mix, select Maintenance - Mixer Data - Upload.**

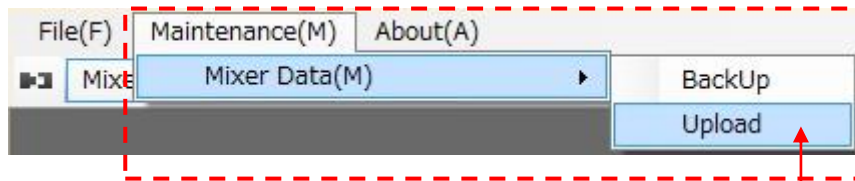

Select Maintenance - Mixer Data - Upload.

- 6 Using the displayed dialog, select the NT110 backup file that has been stored on the PC and press the Upload button.**

Data is transferred from the backup file to NT110. This process takes some time. Wait until it is completed.
 The backup file contains setting (including Setup setting) and all the Preset Program files of NT110.
 After data transfer is completed, the data in the NT110 main unit is replaced with the data in the backup file.

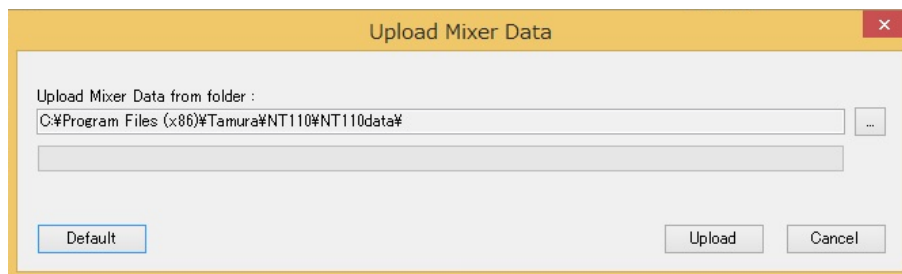

10-10 Factory Default Password

You need to type the factory default password to operate some of the functions such as entering the SETUP screen or locking the PRESET PROGRAM.

Factory default password string: NT110

*You can change this password in the PASSWORD menu of the SETUP screen.

— TAMURA QUALITY CIRCLES THE ELECTRON WORLD —

Customer Service

If you experience any problems with our products and require any servicing, or have any questions about TAMURA product line, please contact your TAMURA sales representative or TAMURA at the following locations.

To help speed up servicing and readjustment, please be ready to describe the problem accurately, what operations you were performing before and after it happened, or the history of usage.

<p style="text-align: center;">NT110 Digital Audio Mixer Instruction Manual (EN)</p>
<p style="text-align: center;">November, 2018 Fourth Edition</p>
<p style="text-align: center;">Part No. 2D-53-0002680C</p>



TAMURA CORPORATION

(Head Office) 1-19-43, Higashi-Oizumi, Nerima-ku, Tokyo, 178-8511 Japan

Phone: +81-3-3978-2111 Fax: +81-3-3923-0230

(Contact)

International Sales Broadcom Business Unit

Phone: +81-3-3978-2242 Fax: +81-3-3978-2005

Addresses and telephone numbers may be changed without notice.

